

# Physiologie moléculaire de la formation du bois

**Annabelle Déjardin**

*Unité Amélioration, Génétique et Physiologie Forestières  
Equipe Physiologie moléculaire de la formation du bois*

INRA Val de Loire

Contact : [annabelle.dejardin@inra.fr](mailto:annabelle.dejardin@inra.fr)



# Préambule

Définition d'un arbre ?



Séquoïas (100 m , 2000 ans)



L'arbre de la connaissance du Bien et du Mal  
Tableau de Lucas Cranach l'Ancien.



Le pin de Bristlecone Mathusalem,  
Californie, USA, 4850 ans

Définition : plante terrestre capable de se développer en hauteur, en général **au delà de plusieurs mètres**, grâce à une structure rigide composée d'un tronc qui peut éventuellement se ramifier en formant des branches.

L' arbre est une plante **pérenne** qui vit plusieurs années, le plus souvent **plusieurs décennies**, ou même **plusieurs siècles**.

Physiologie particulière :

- ancrage des racines dans le sol
- résistance mécanique de la tige / tronc
- passage hiver - dormance des bourgeons
- accumulation de réserves pendant la belle saison
- résistance accrue aux aléas climatiques

**Formation du bois ou xylème secondaire**

## Plan du cours

Introduction : le bois pour l'homme / pour l'arbre

La formation du bois

Mécanismes moléculaires de la formation du bois – qqes exemples

Stratégies / Modèles d'étude / Approches

Contrôle de l'activité cambiale

Régulation transcriptionnelle de la formation des parois secondaires

Contrôle de l'angle des microfibrilles de cellulose

Mort cellulaire

Conclusion

A detailed microscopic view of wood tissue, showing various cell types such as tracheids, vessels, and fibers. The cells are arranged in a complex, interconnected pattern, with some showing distinct growth rings and others showing more uniform structures. The overall appearance is that of a highly organized biological structure.

# Utilisations du bois par l'homme / son rôle pour l'arbre

**Bois = à la fois matériau, matière première et source d'énergie renouvelable**

**Utilisation traditionnelle dans la construction, l'ameublement, la fabrication de papier, le bois de chauffage**



# Bois = à la fois matériau, matière première et source d'énergie renouvelable

## Utilisations plus récentes

matériaux composites bois



OSB



MDF



aggloméré



faible densité

Bois énergie

Plaquettes



Granulés



## produits semi-finis de construction bois





## Utilisations innovantes

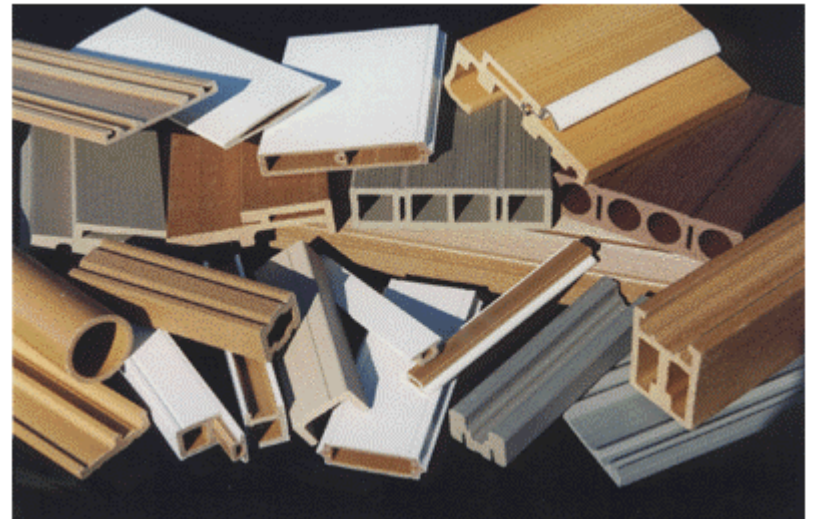

Bois moulé

Bois extrudé

# Utilisations futures : bioéthanol de seconde génération

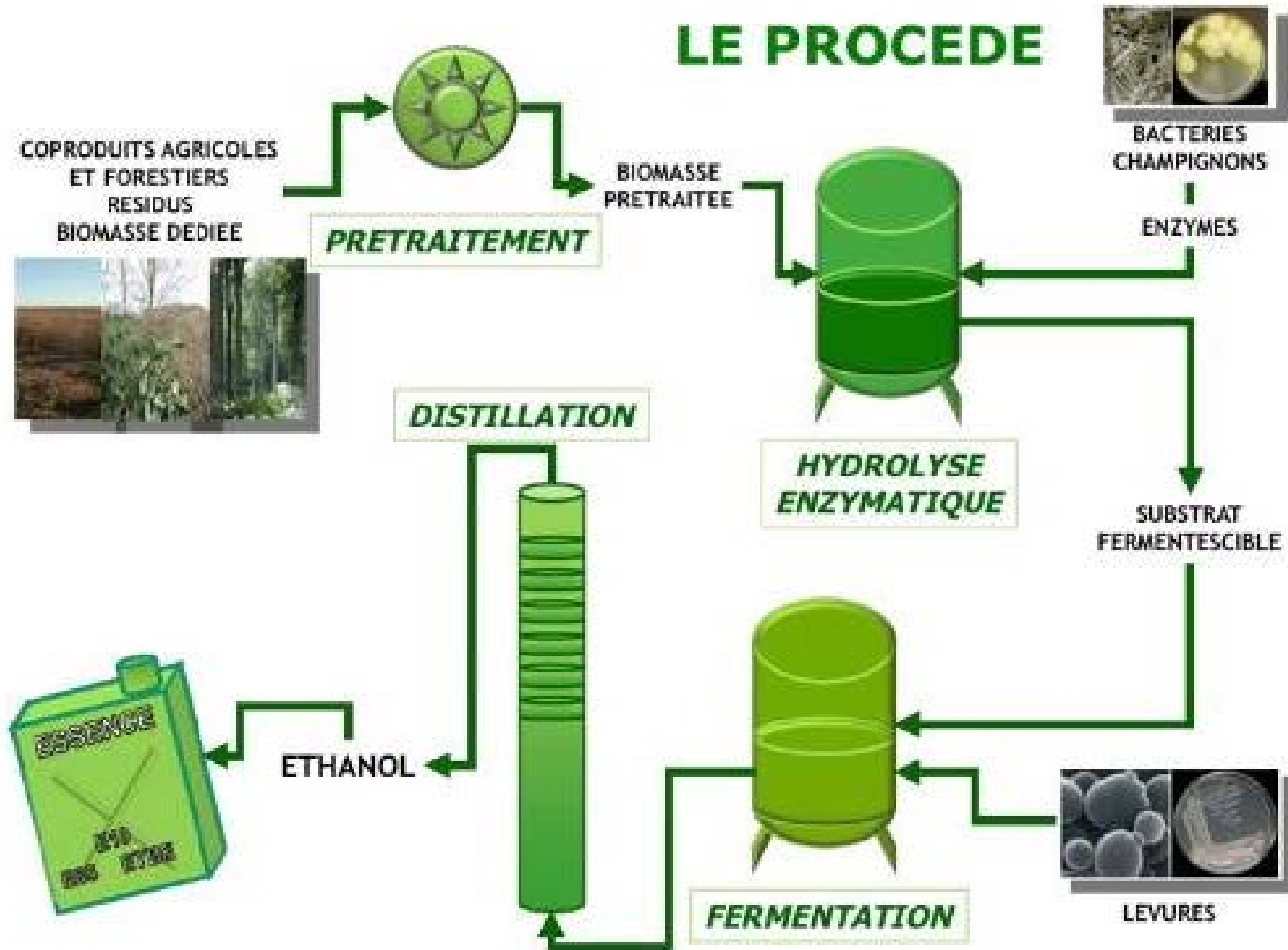

# A quoi sert le bois pour l'arbre?

Conduire l'eau des racines jusqu'au houppier

Supporter la masse en constante croissance de l'arbre

Stocker des réserves



# Le bois est composé de différents types cellulaires

Bois d'arbres feuillus = bois hétéroxylé

Bois = Xylème secondaire



**Chataignier**

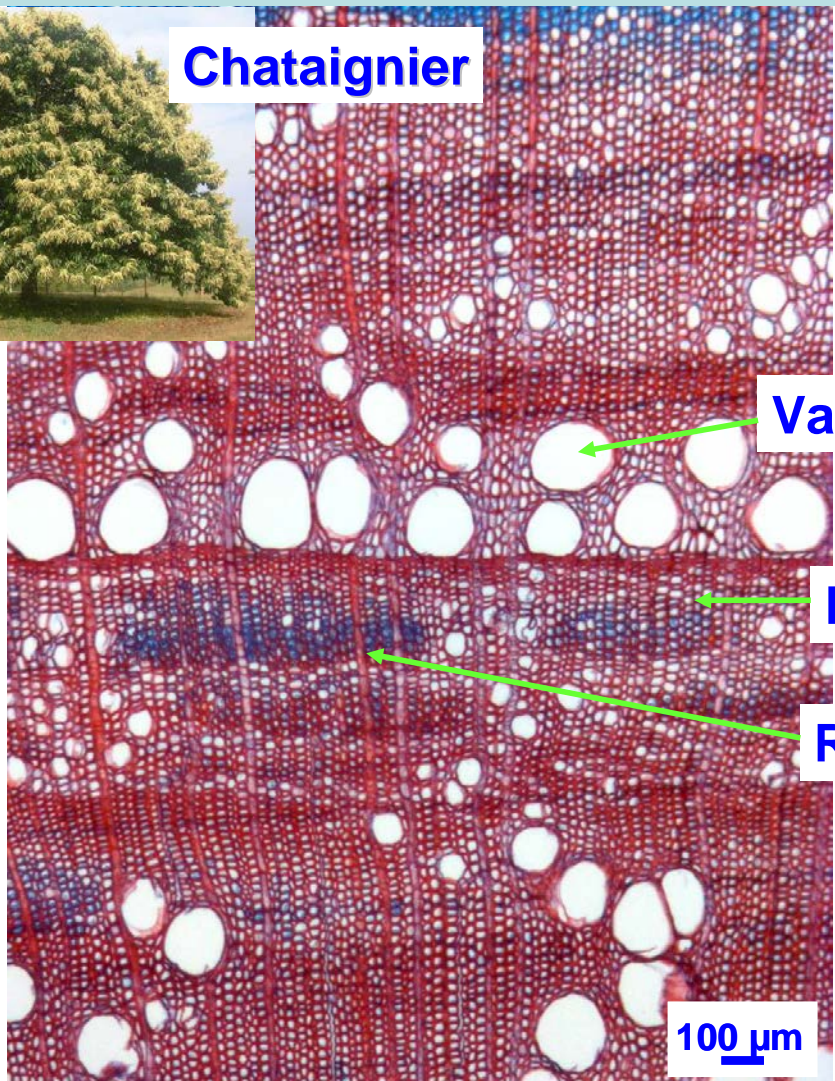

**Vaisseaux**

**Fibres**

**Rayons**

100  $\mu$ m



**Robinier**

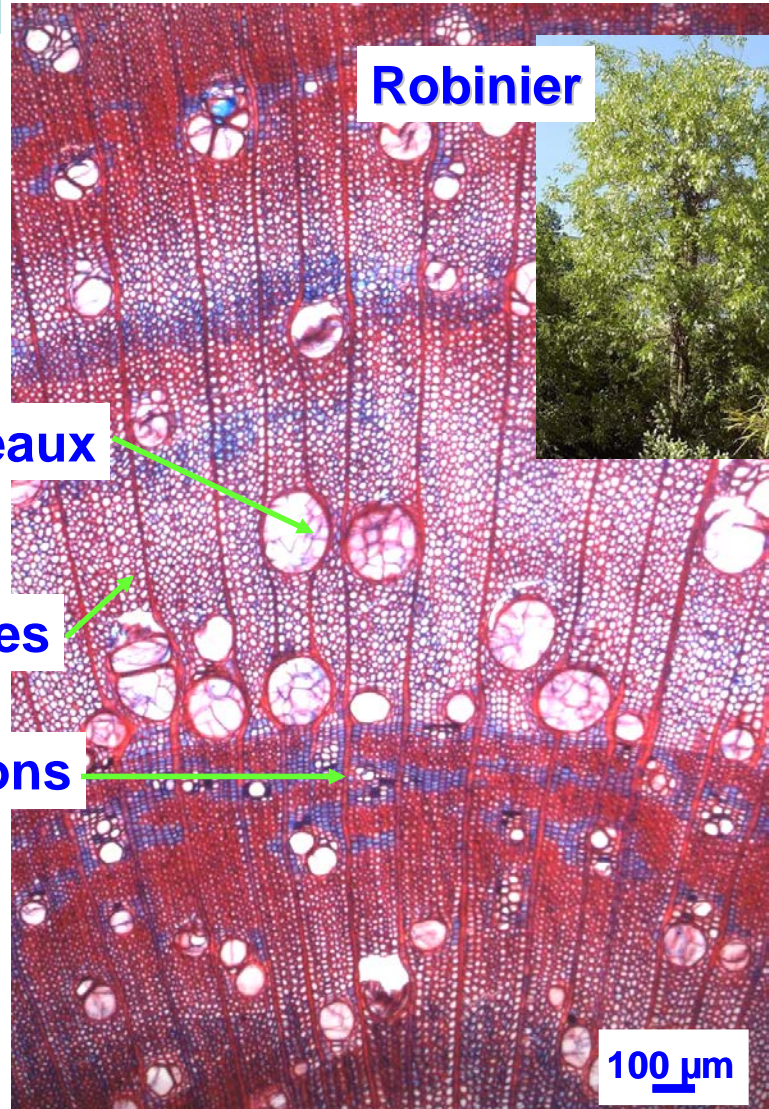

100  $\mu$ m

# Le bois est composé de différents types cellulaires

Bois de résineux = bois homoxylé

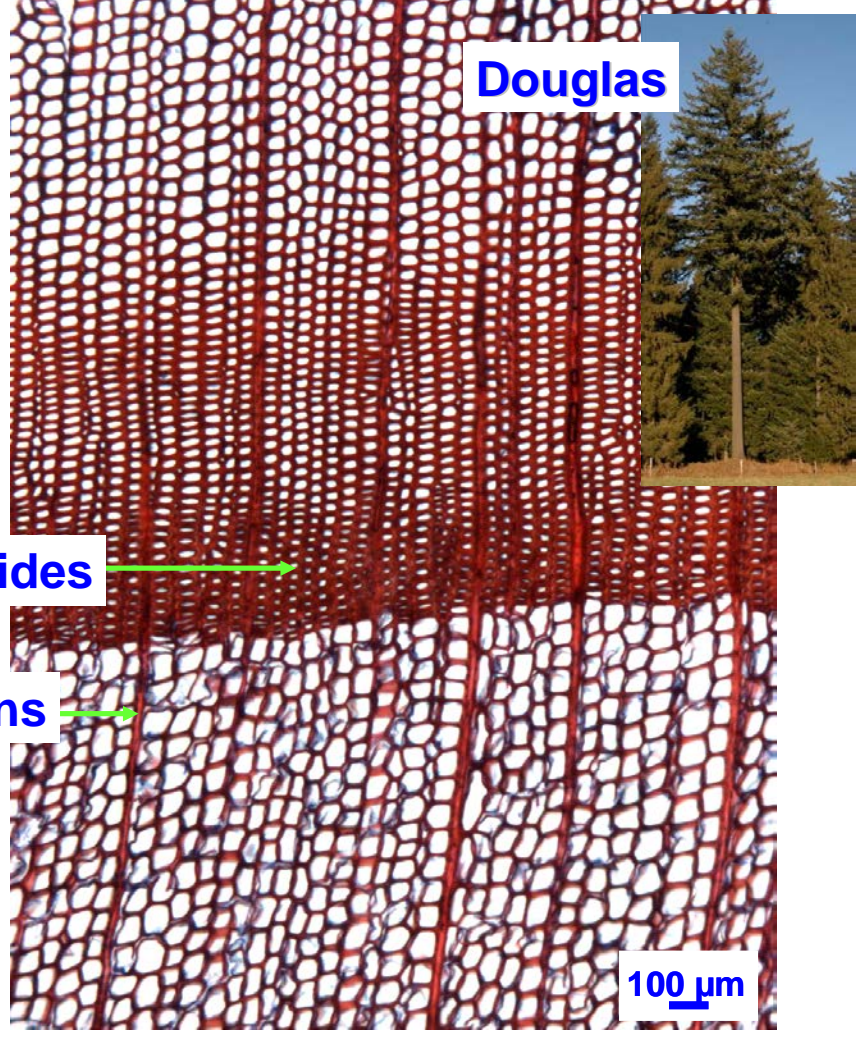
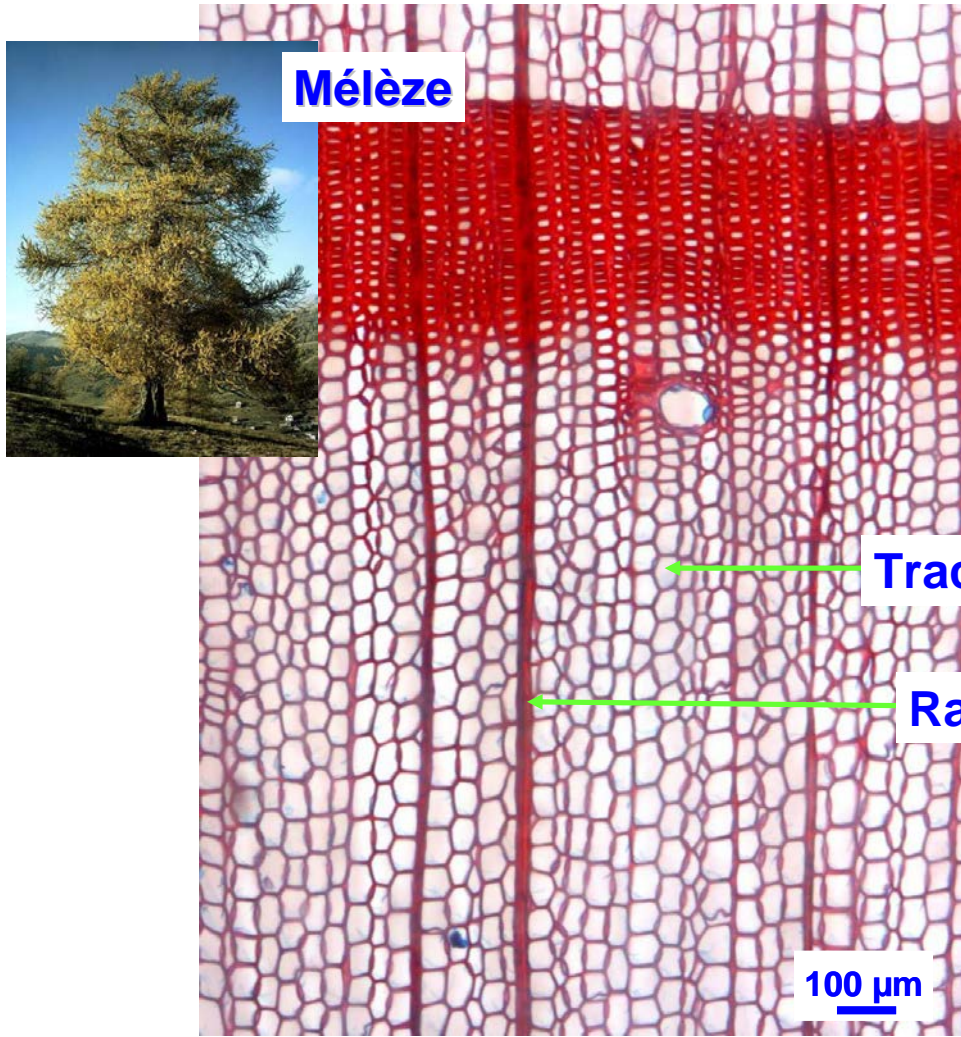

# Fibres et vaisseaux

Peuplier

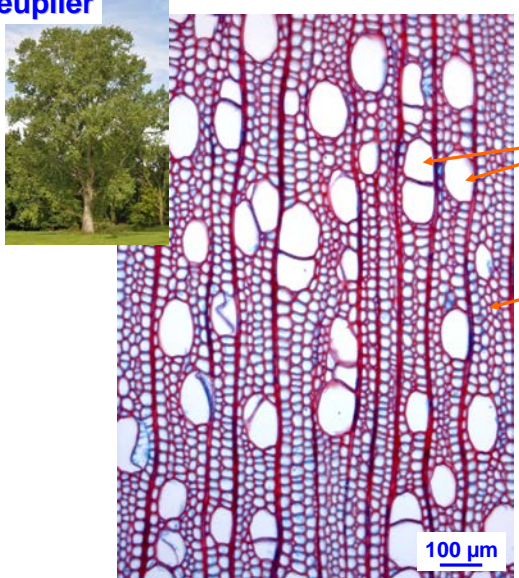

Coupe transversale de bois observée au microscope optique

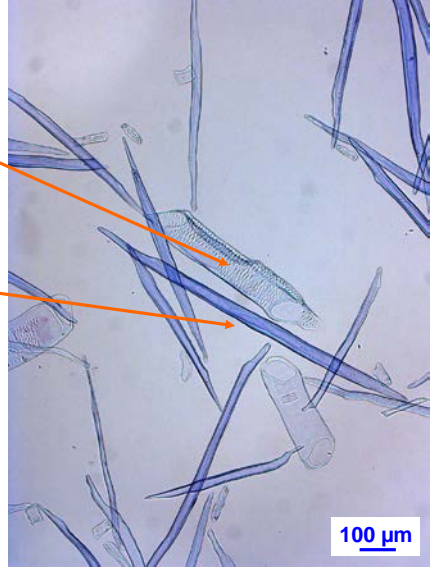

Fibres de bois et éléments de vaisseaux séparés par macération

Fibre  
Parois cellulaires d'une fibre  
Vaisseaux

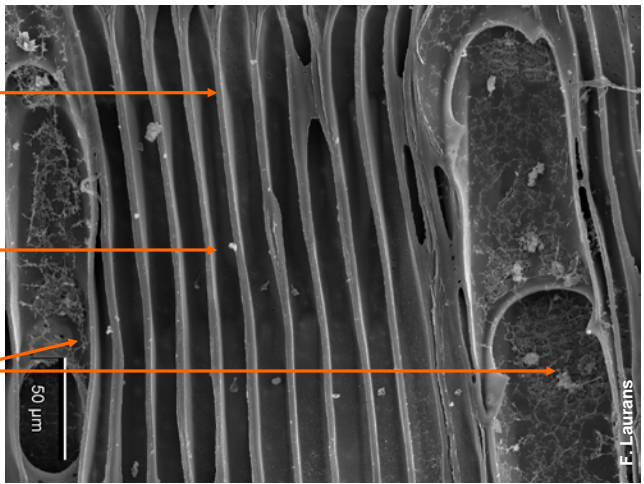

Coupe longitudinale de bois observée au microscope électronique à balayage.

# Le bois est variable entre espèces (essences)

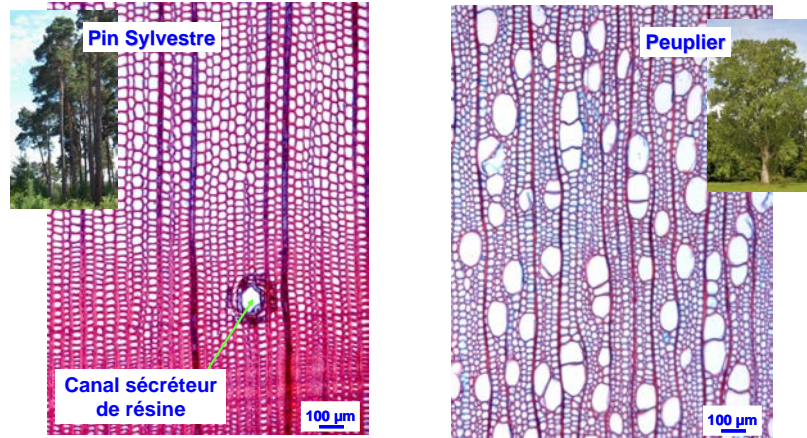

Les 3 plans d'observation de la structure du bois

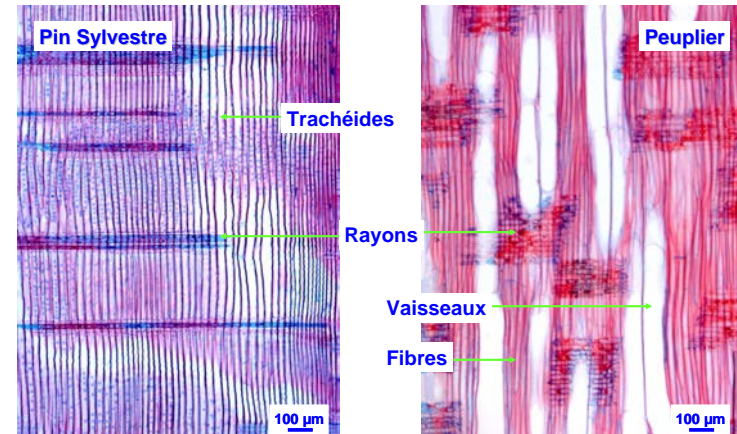
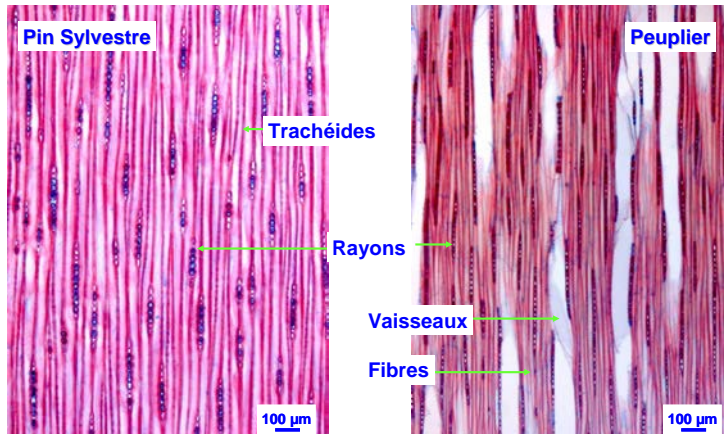
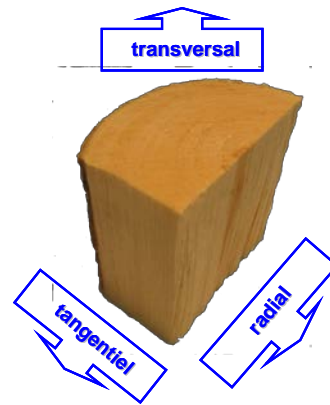

Fonction	Feuillus Angiospermes	Résineux Gymnospermes
Conduction de la sève brute	Vaisseaux	Trachéides
Soutien	Fibres	Trachéides
Stockage des réserves et communication entre cellules	Parenchyme des rayons	Parenchyme des rayons



# Le bois est variable au sein d'une même espèce, d'un même individu

Bois de printemps (initial) / bois d'été (final)

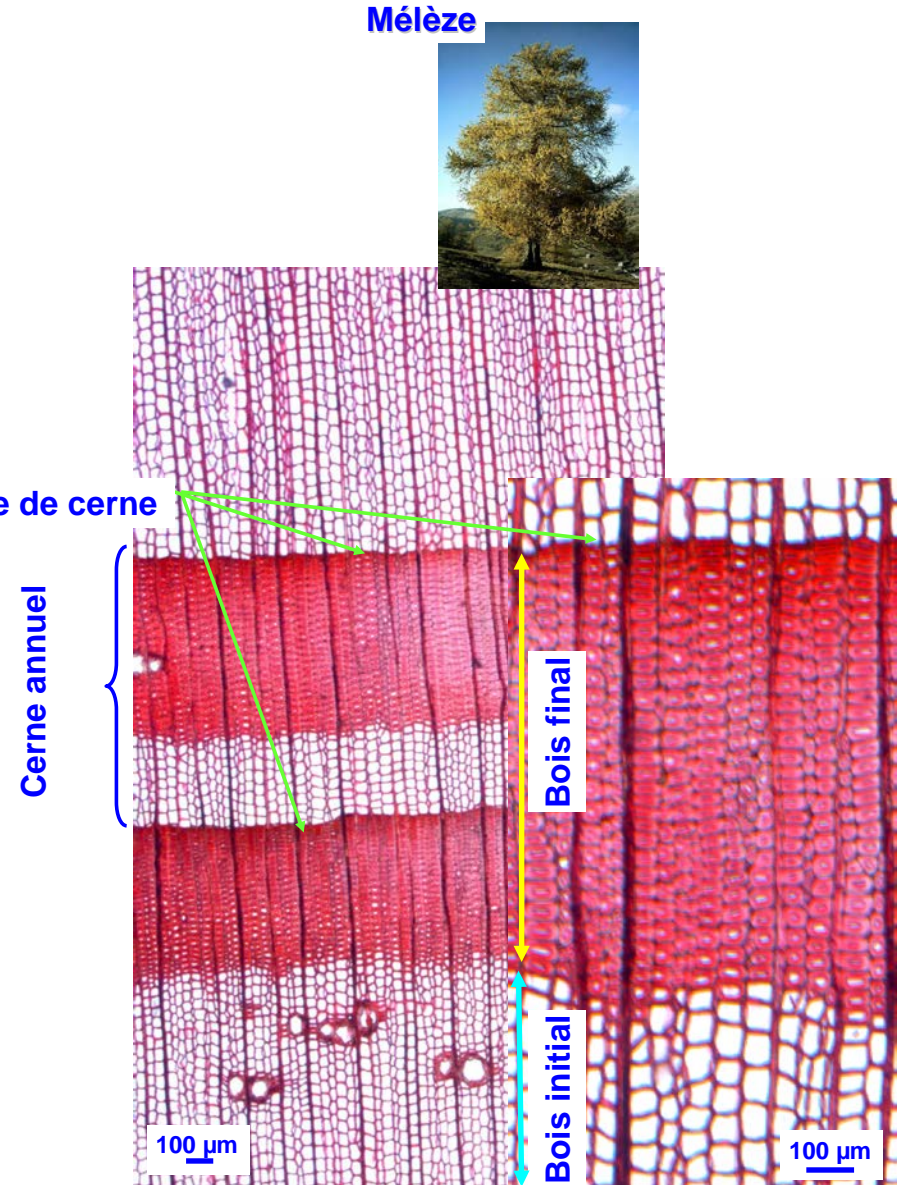
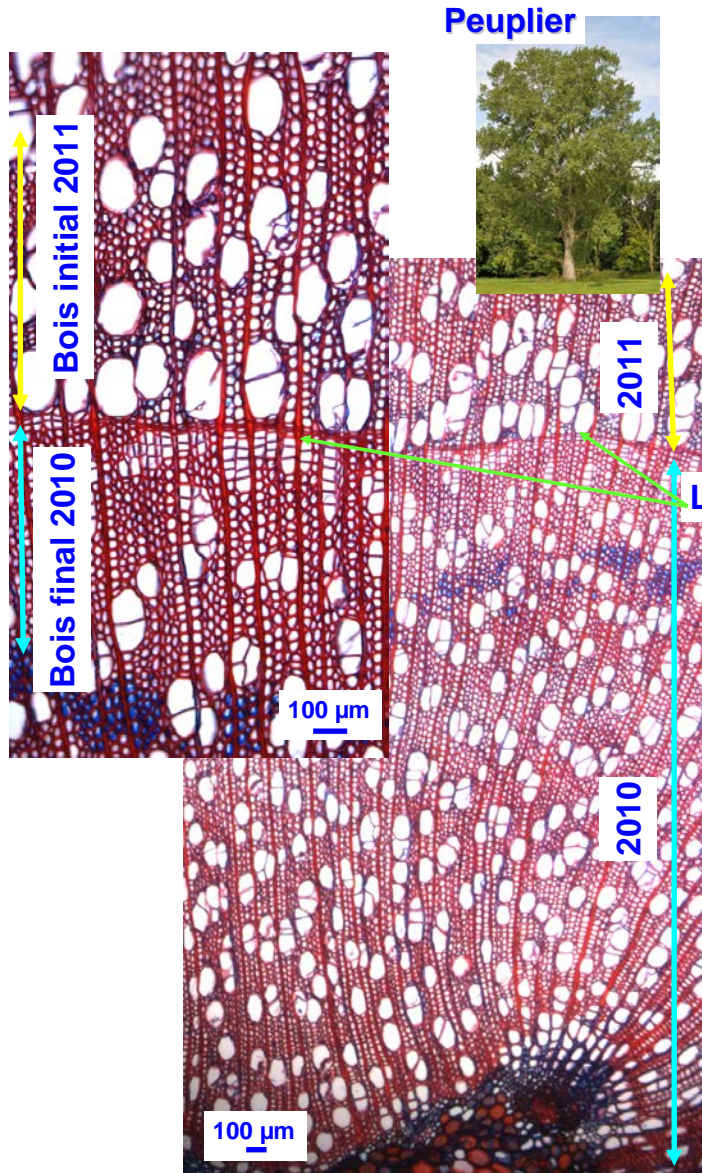

# Le bois répond aux conditions environnementales

## Contraintes hydriques



Faux cerne

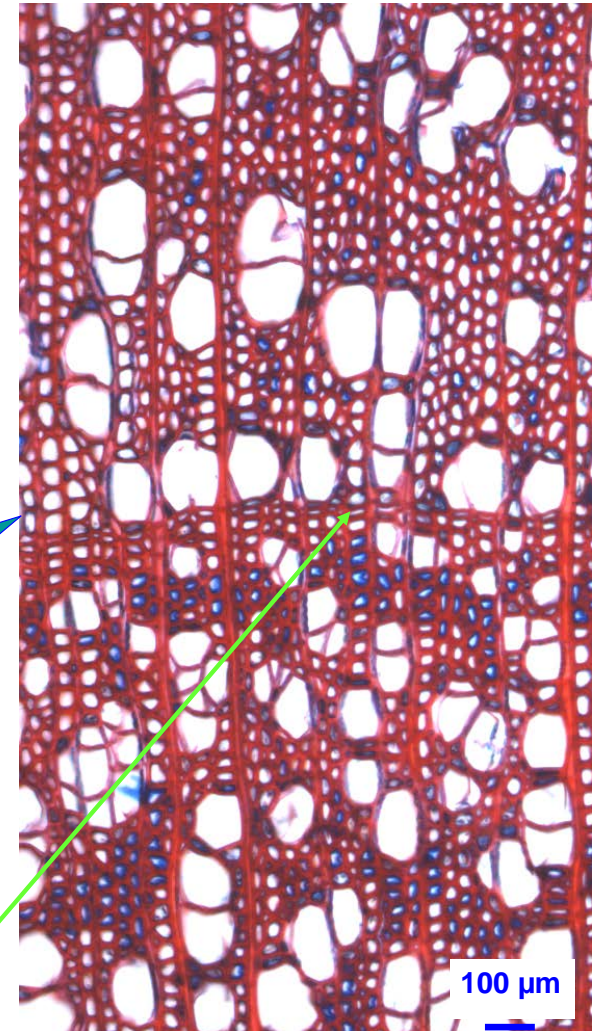



# Le bois répond aux conditions environnementales

## Contraintes mécaniques

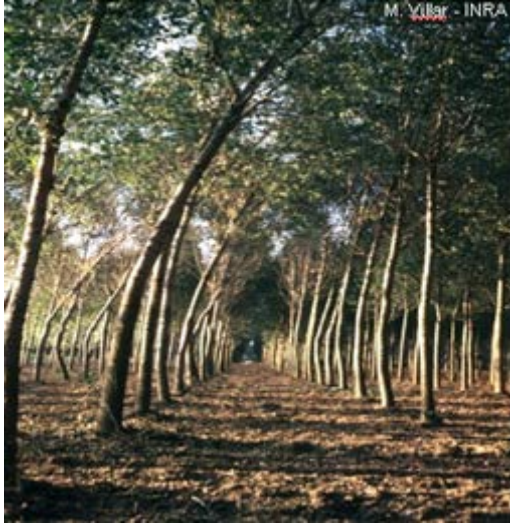

Chez les arbres feuillus, le bois de tension possède des propriétés mécaniques particulières permettant à l'arbre de réorienter ses axes ...

Face supérieure

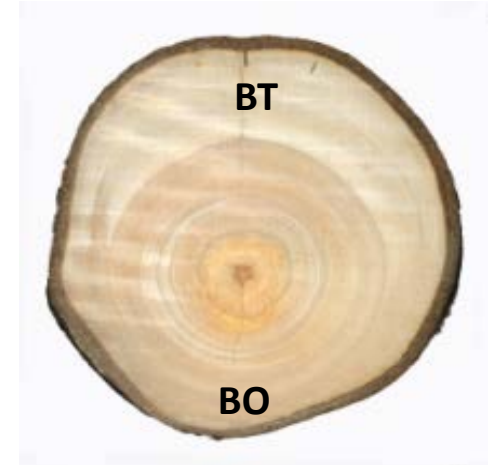

Face inférieure



... et de garder un certain équilibre...

# Un peu de mécanique : comment le bois de tension est-il le moteur du redressement des axes de l'arbre ?

UMR-PIAF (Clermont Ferrand)

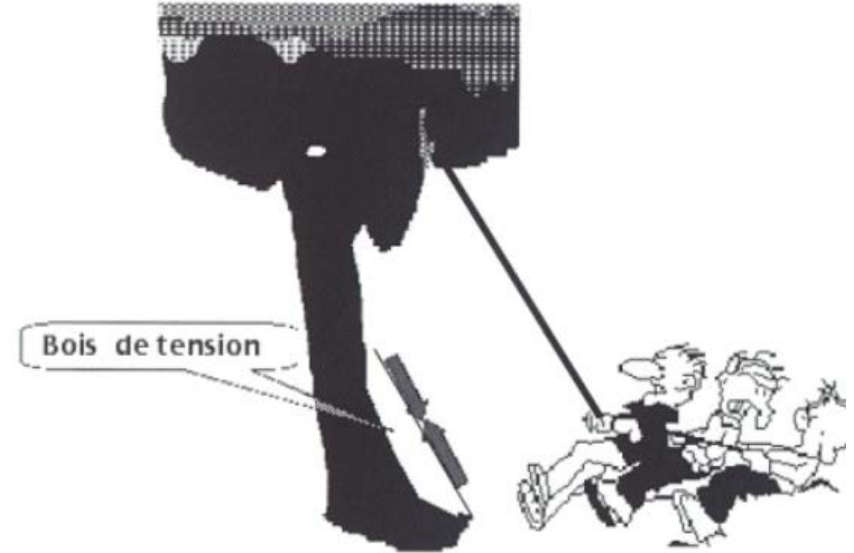
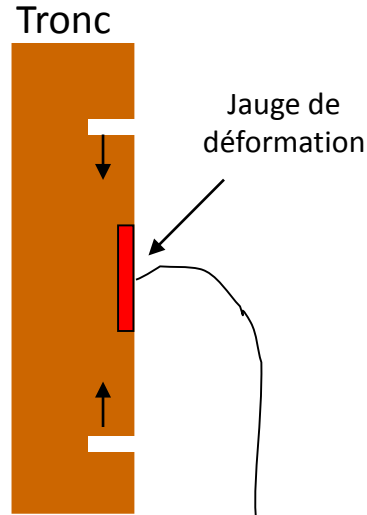

Le déplacement enregistré est une mesure de la contrainte longitudinale, en périphérie du tronc.

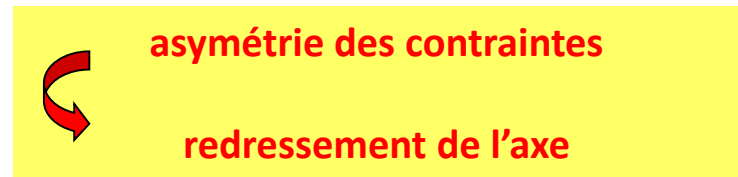

Retrait longitudinal

Peuplier

Bois normal  $-300 \mu\text{m}/\text{m}$

**Bois de tension**  $-3000 \mu\text{m}/\text{m}$

(Clair et al., 2006)

## Ces propriétés macroscopiques ont pour origine la structure très particulière du bois de tension



*Populus tremula x P. alba*,  
clone INRA 717-1B4

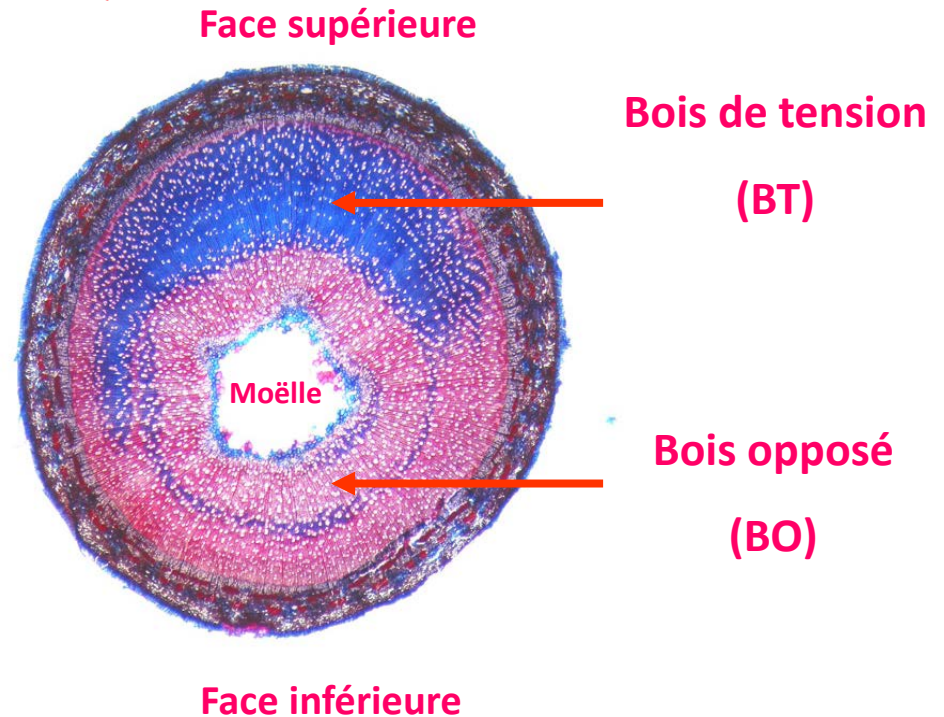

CT tige de Peuplier - Coloration Safranine/Bleu Astra

**2 principales réponses à l'inclinaison :**

- **Augmentation des divisions cellulaires**
- **Différenciation de fibres particulières**

# Le bois répond aux conditions environnementales

## Contraintes mécaniques

### Bois de tension chez les feuillus

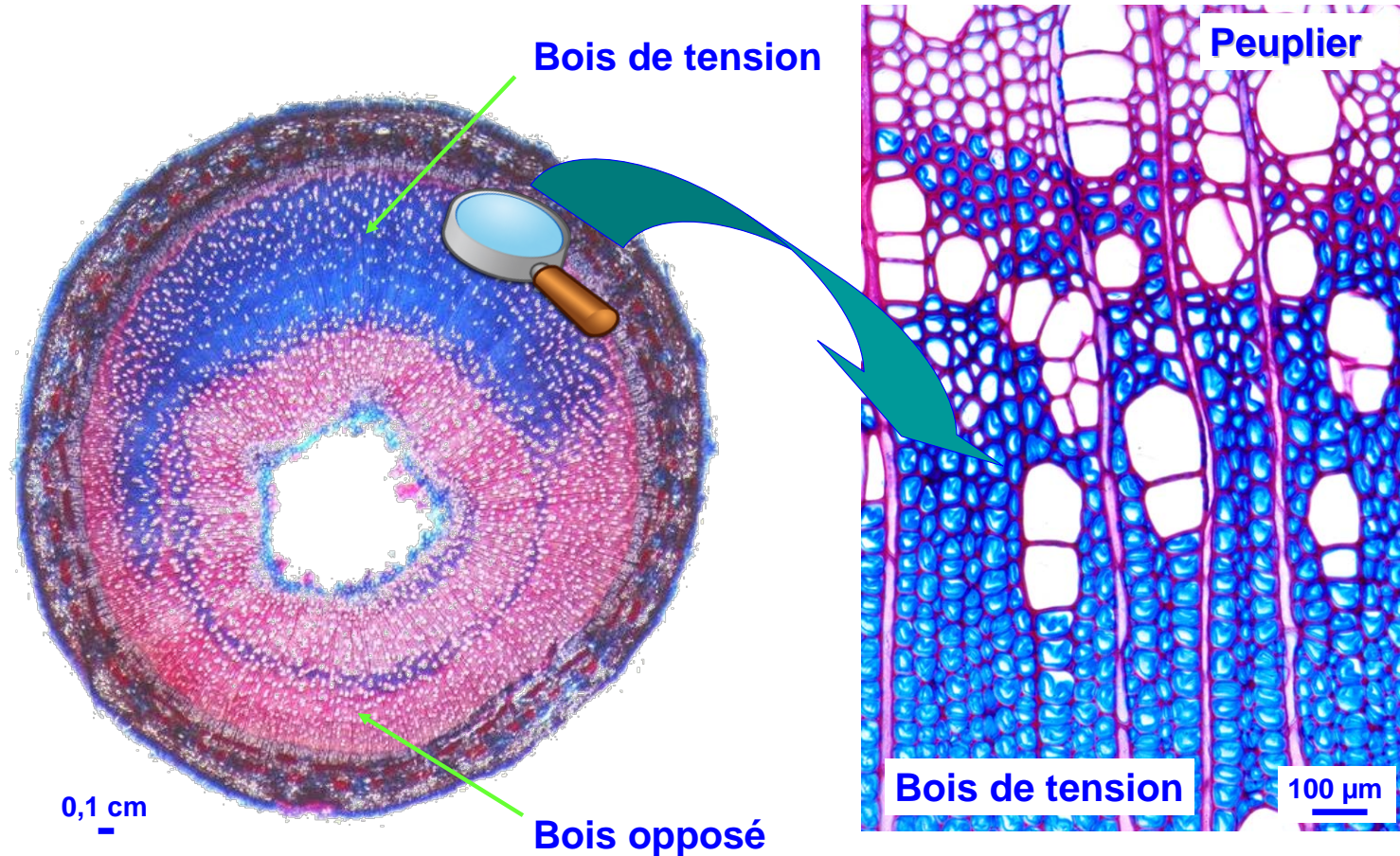

# Le bois répond aux conditions environnementales

## Contraintes mécaniques

### Bois de compression chez les résineux

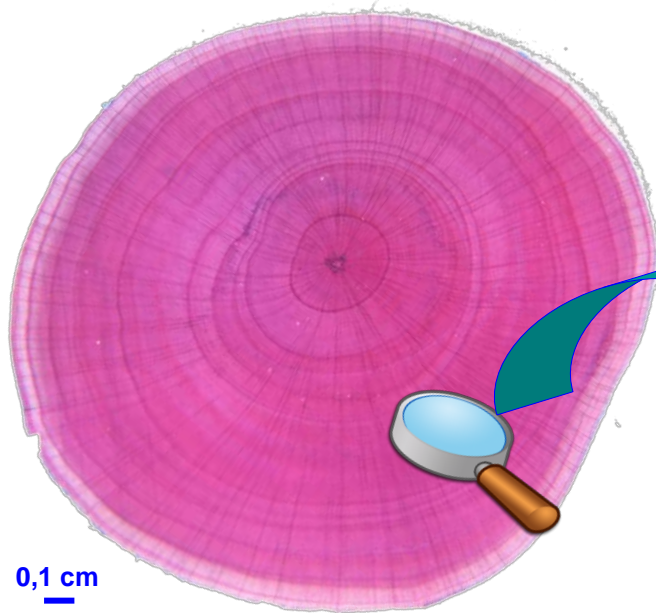

0,1 cm

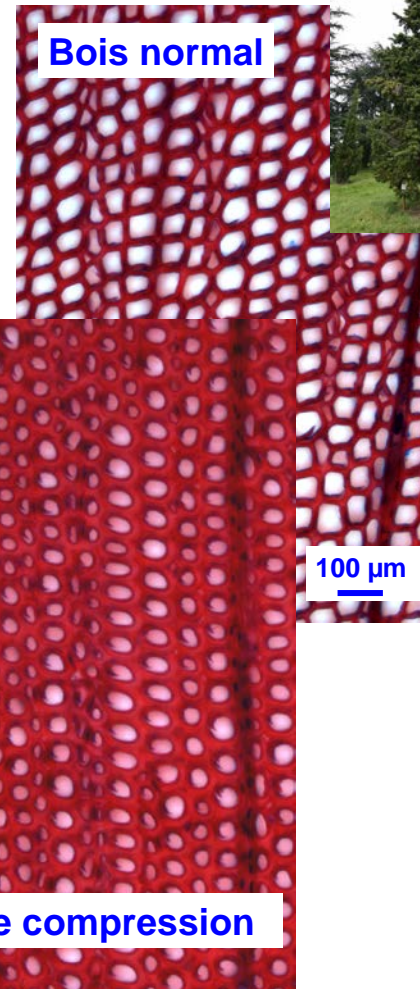

Bois normal

100 μm

Bois de compression



Cyprès



aubier / bois de cœur

CT Noyer

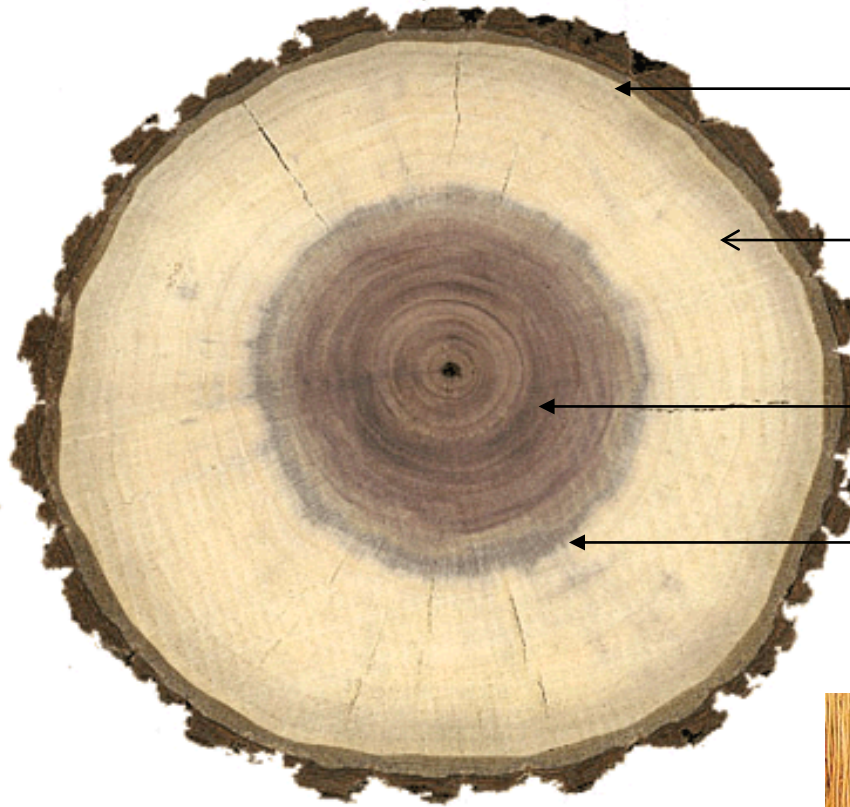

Jeune xylème en  
différenciation

Aubier

Bois de cœur ou  
Duramen

Zone de transition



A detailed microscopic cross-section of wood tissue. The image shows a complex arrangement of cells, including large vessels with thick, multi-layered walls and smaller tracheids. The cells are stained, highlighting their structural details and the overall organization of the wood. The text "Formation du bois" is overlaid in the center in a bold, blue font.

# Formation du bois

# La formation du bois est un processus de développement complexe

Ecorce

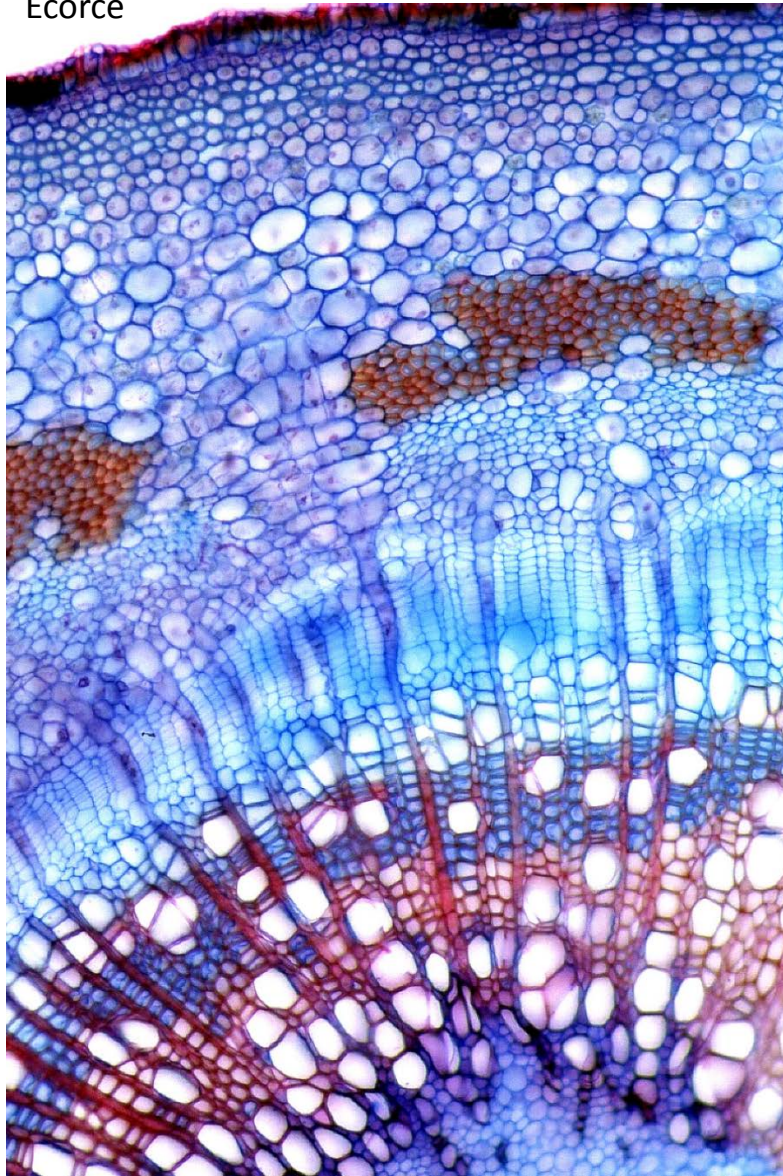

CT tige de Peuplier  
Coloration Safranine/Bleu Astra

Phloème II

Division cellulaire

Zone cambiale

Elongation cellulaire

Xylème II  
=  
bois

Différenciation  
(vaisseaux, fibres, rayons)

Formation des parois secondaires  
lignifiées

Mort cellulaire

Moëlle

# Le bois est formé essentiellement de l'enchevêtrement tridimensionnel de parois de cellules mortes

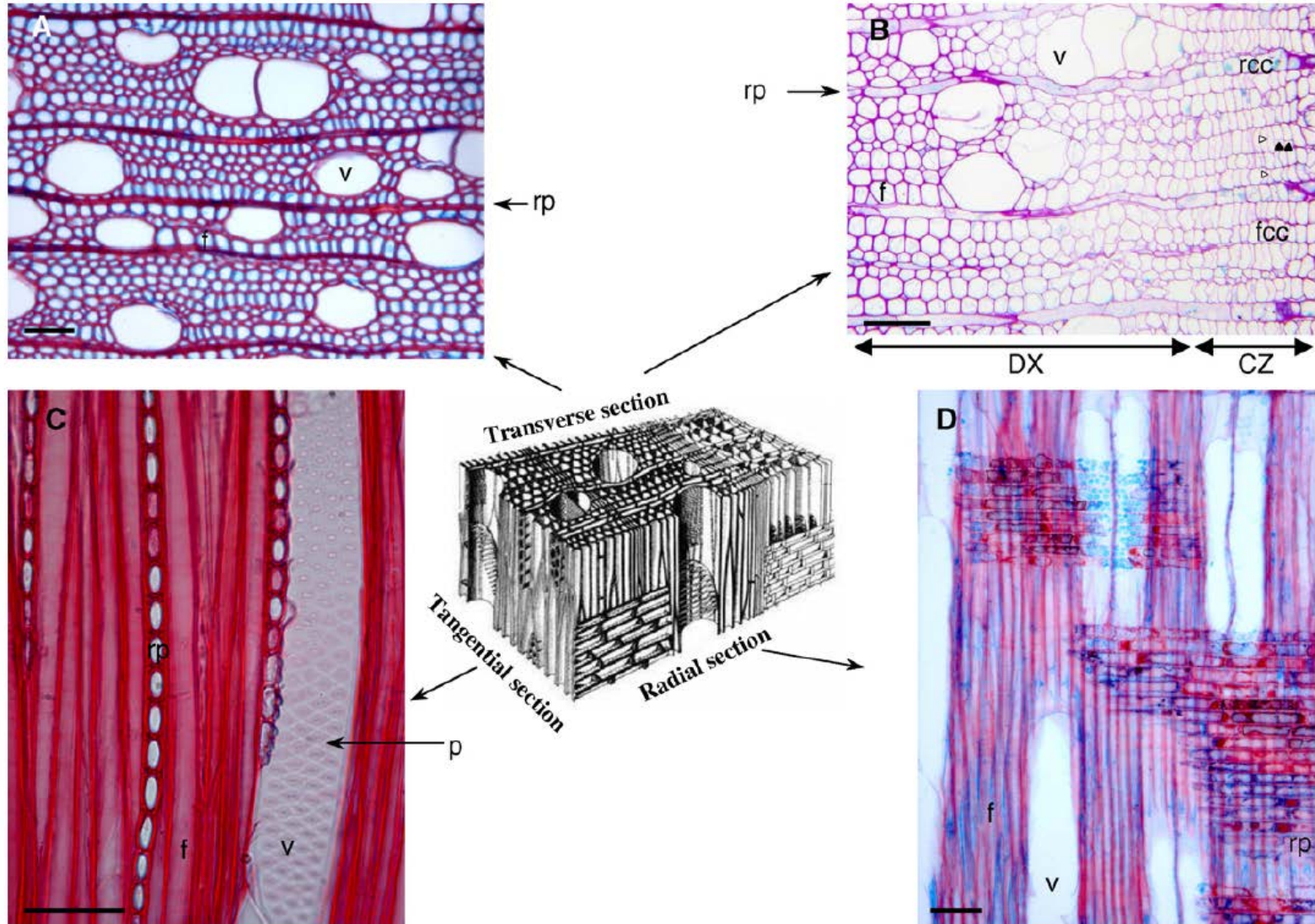

# Le bois est formé essentiellement de l'enchevêtrement tridimensionnel de parois de cellules mortes

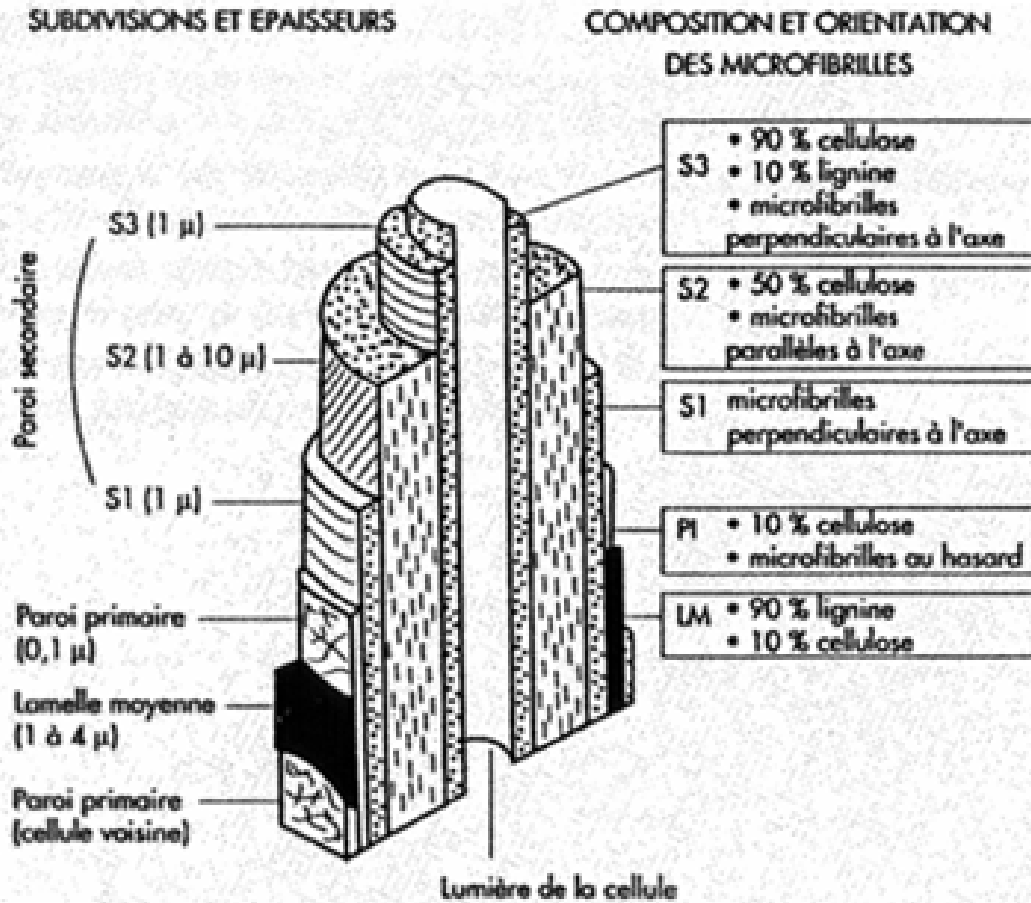

La paroi secondaire est composée de plusieurs couches qui diffèrent par :

- Épaisseur
- Angle des microfibrilles de cellulose
- Degré de cristallinité de la cellulose
- Contenu en lignines

Propriétés chimiques et mécaniques du bois

# Dans la paroi des fibres de bois, les lignines cimentent les câbles de cellulose

Pour l'arbre, les lignines sont indispensables pour :

- le support mécanique
- le transport de la sève
- la résistance aux pathogènes

Problème d'accessibilité des microfibrilles de cellulose

(papier, bioéthanol)

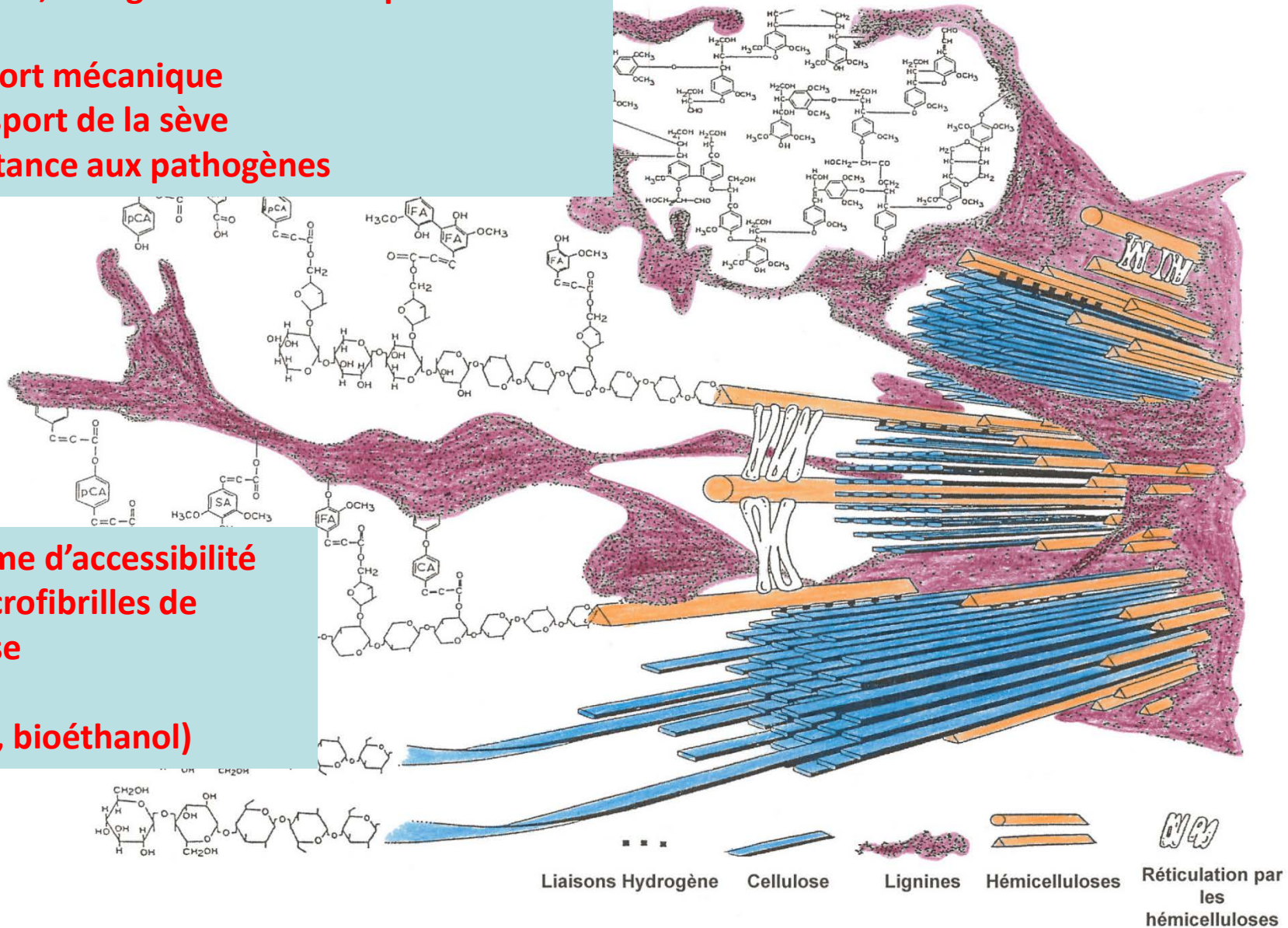

# Les fibres G présentent, dans leur paroi, une couche très riche en cellulose

Face opposée

Face tendue

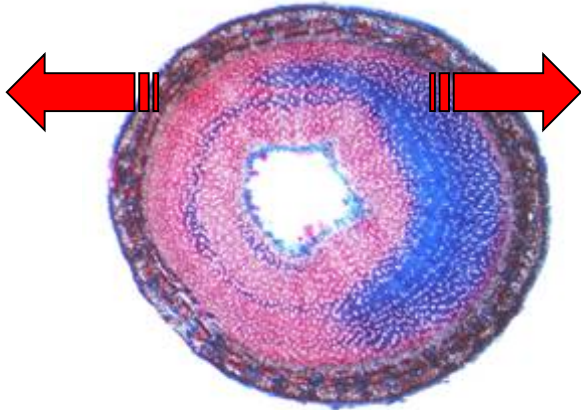
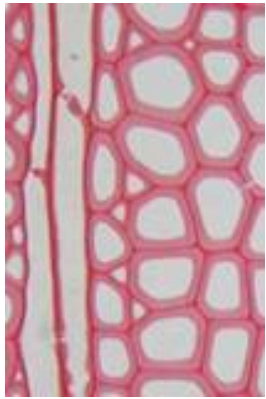

CT tige de Peuplier  
Coloration Safranine/Bleu Astra

- Cellulose très cristalline, organisée en microfibrilles de 30 à 40 nm de  $\phi$  (Daniel et al., 2006)
- AMF proche de  $0^\circ$
- pas ou peu de lignines
- Autres polysaccharides : xyloglucanes, glucomannanes et arabinogalactanes (Nishikubo et al., 2007)

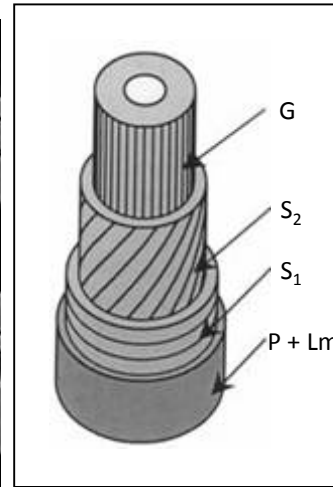
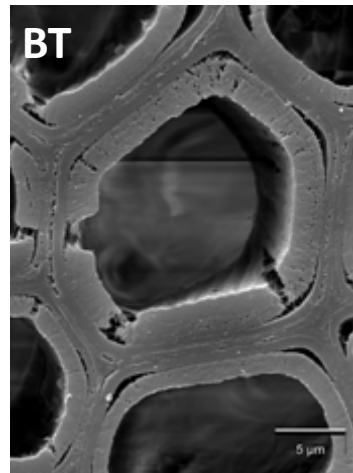
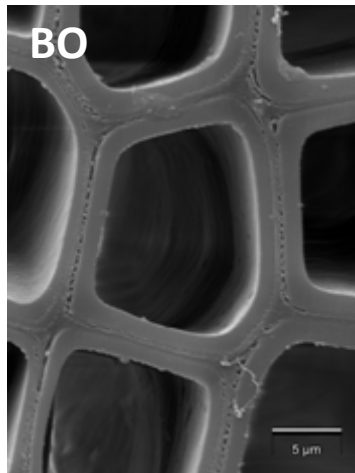
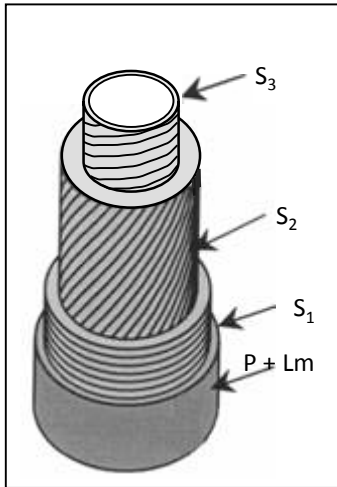

Microscopie électronique à balayage

# Déconstruction de la biomasse lignocellulosique

Prétraitement pour séparer les composants de la paroi et libérer l'accès à la cellulose

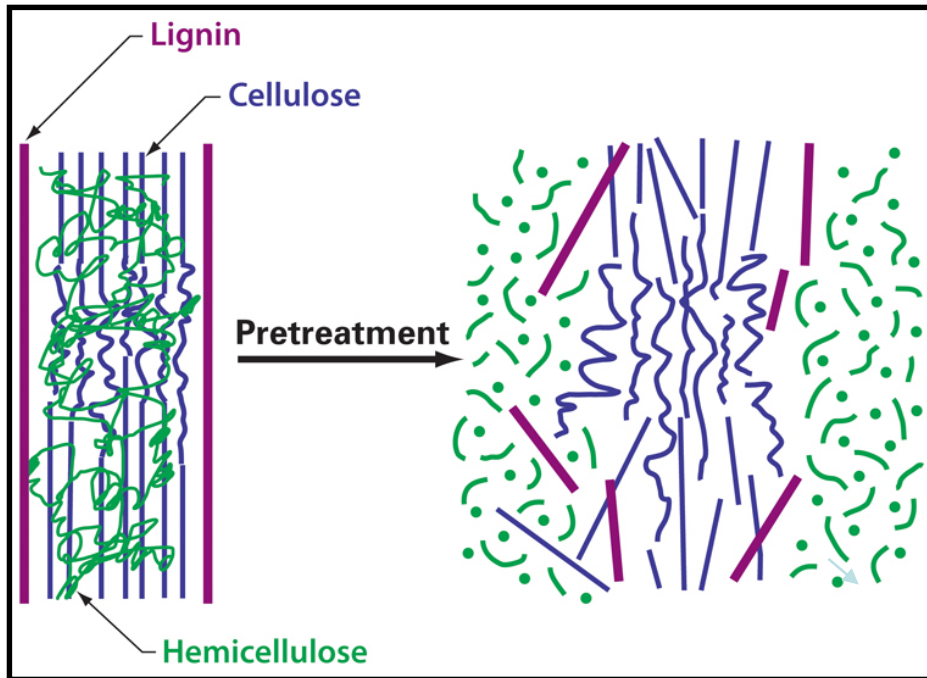

**Hydrolyse acide / alcaline / Explosion à la vapeur...**

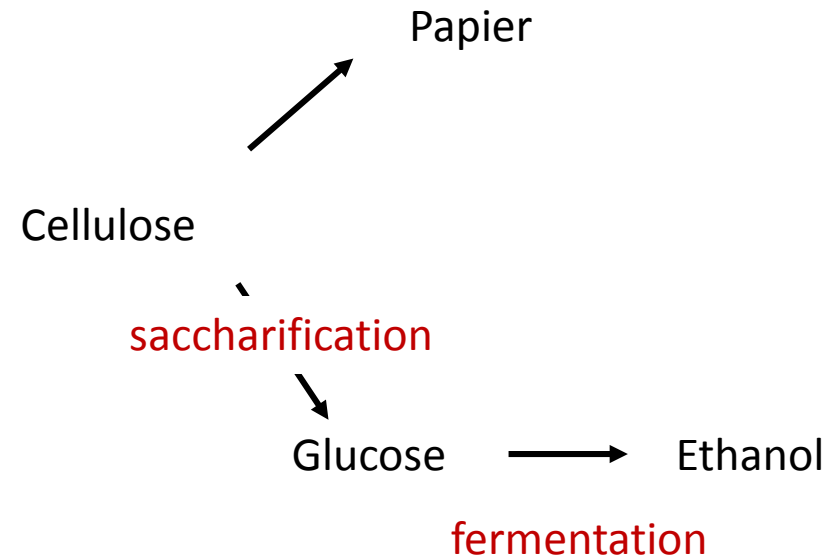

Lignines : énergie ... composés à haute valeur ajoutée (substituant phénol)

Hémicelluloses : valorisation et fermentation des sucres en C5



# Les différentes étapes de la formation du bois : lien processus biologiques / propriétés du bois

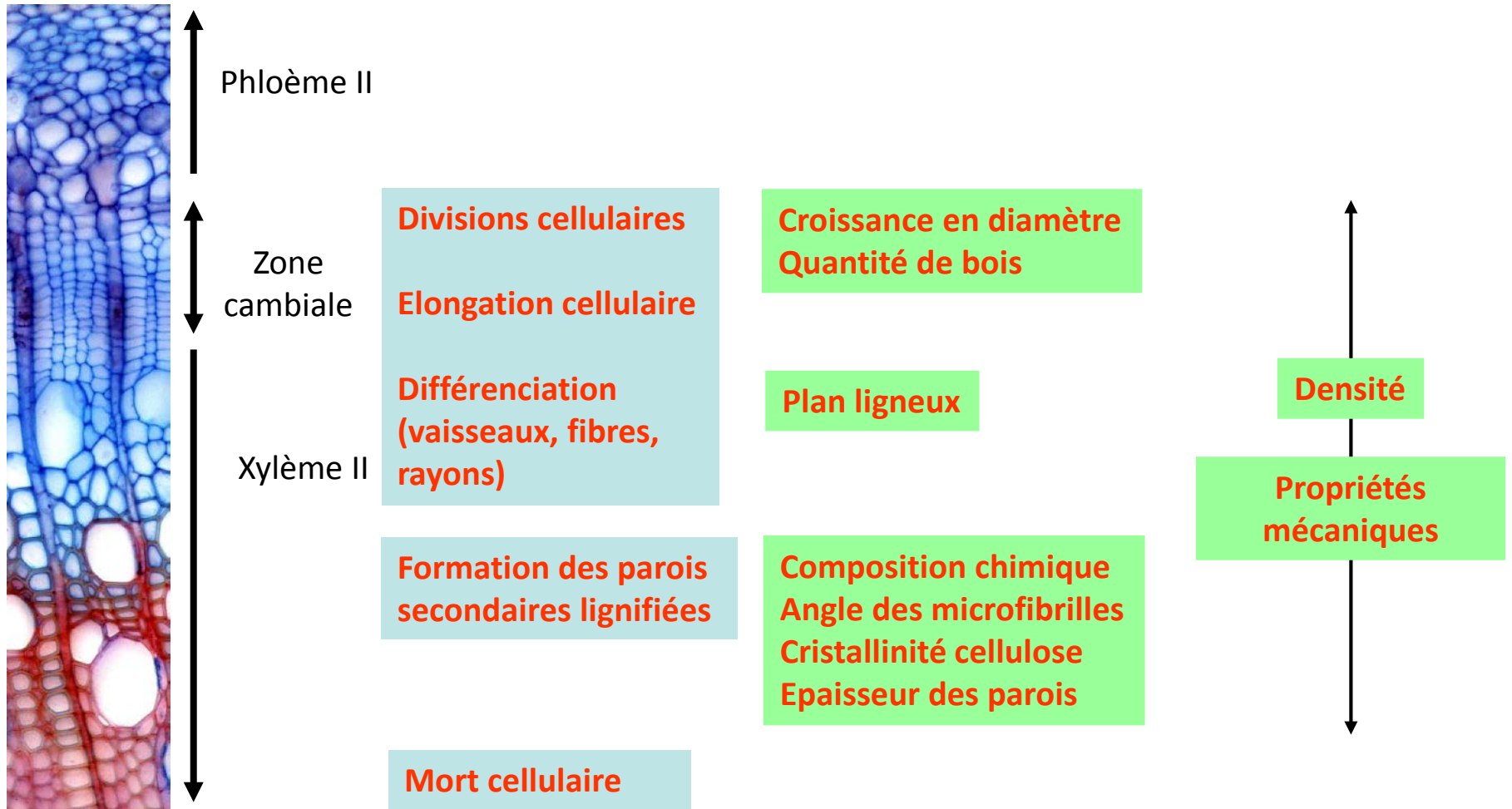

CT tige de Peuplier - Coloration  
Safranine/Bleu Astra

(Plomion et al. 2001, Déjardin et al. 2010)

# Le cambium est formé de deux types d'initiales

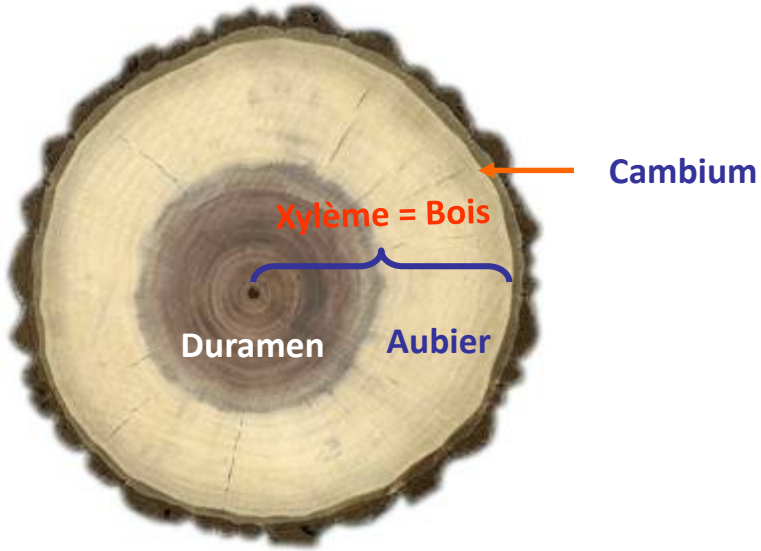

Cellules disposées en files régulières  
Parois minces cellulosiques

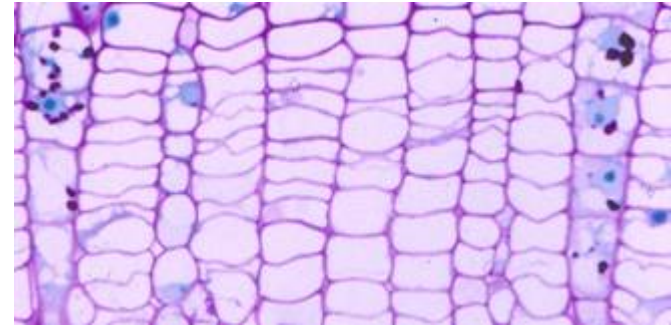

Initiales fusiformes

Vaisseaux

Fibres

Initiales radiales

Rayons

Fig. 1 Micrographs of lyophilized, microdissected poplar (*Populus trichocarpa* × *Populus deltoides* var. *Boeclere*) cambial cells: (a) Fusiform cambial cells; (b) radial cambial cells. Bars, 10 µm.

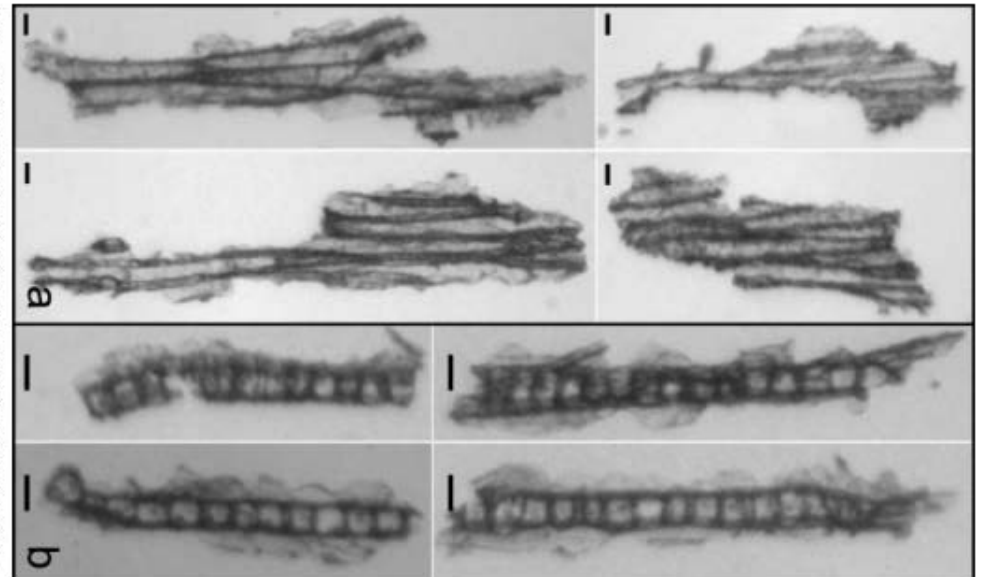

(Goué et al., 2008)

# Fonctionnement du cambium

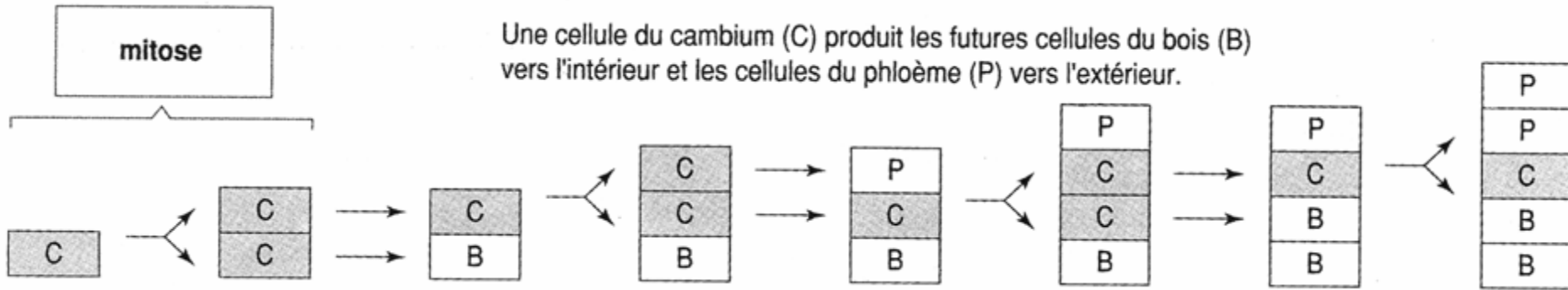

Hiver

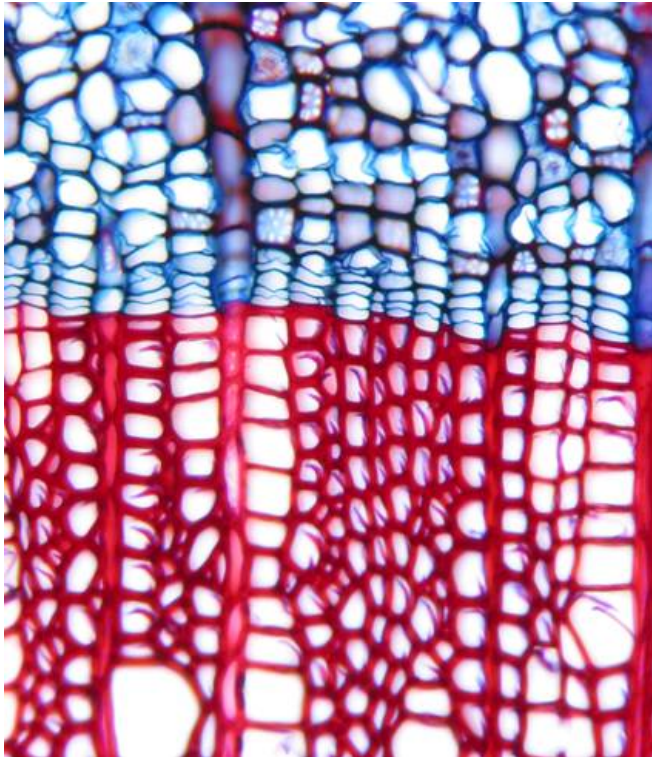

Printemps

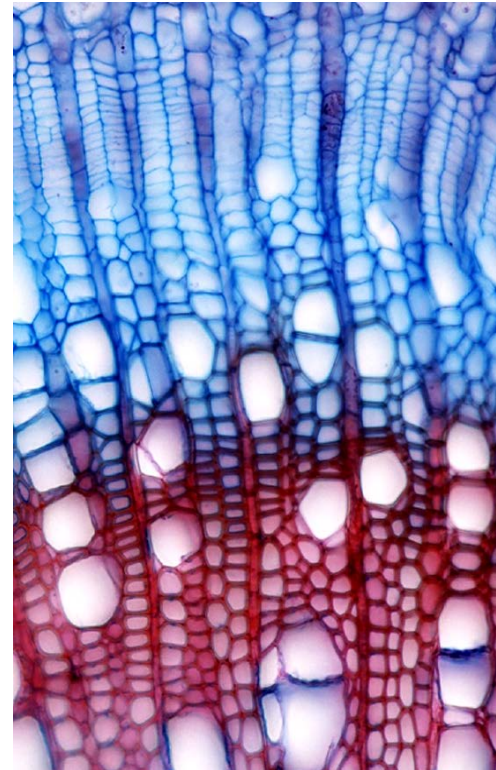

# Fonctionnement du cambium

Ex : Epicéa

**A Dormant cambium**

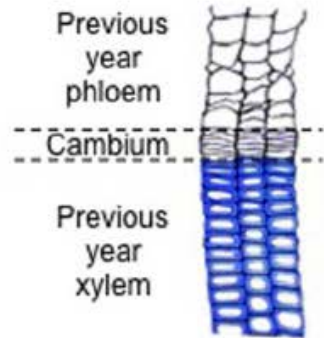

**B Active cambium**

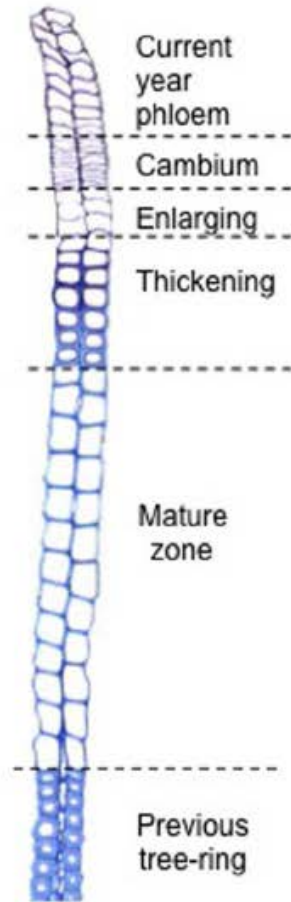

**C Developing radial file**

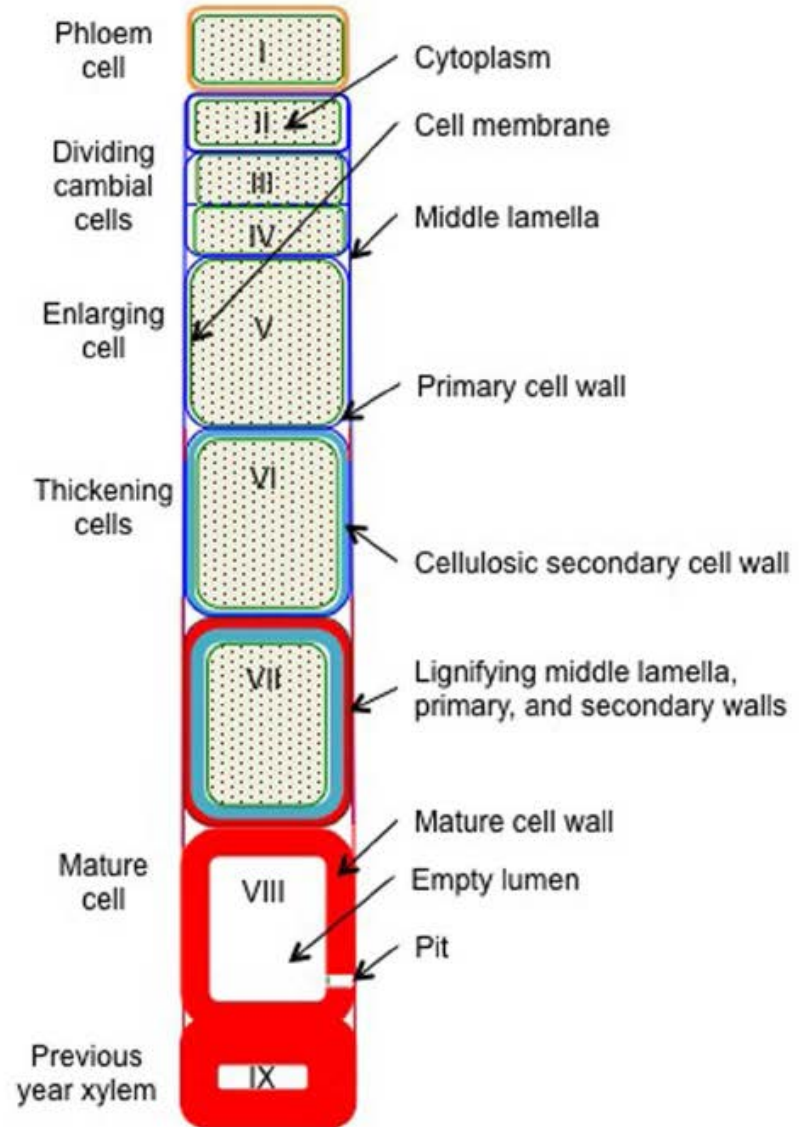

# Fonctionnement du cambium : une activité saisonnière

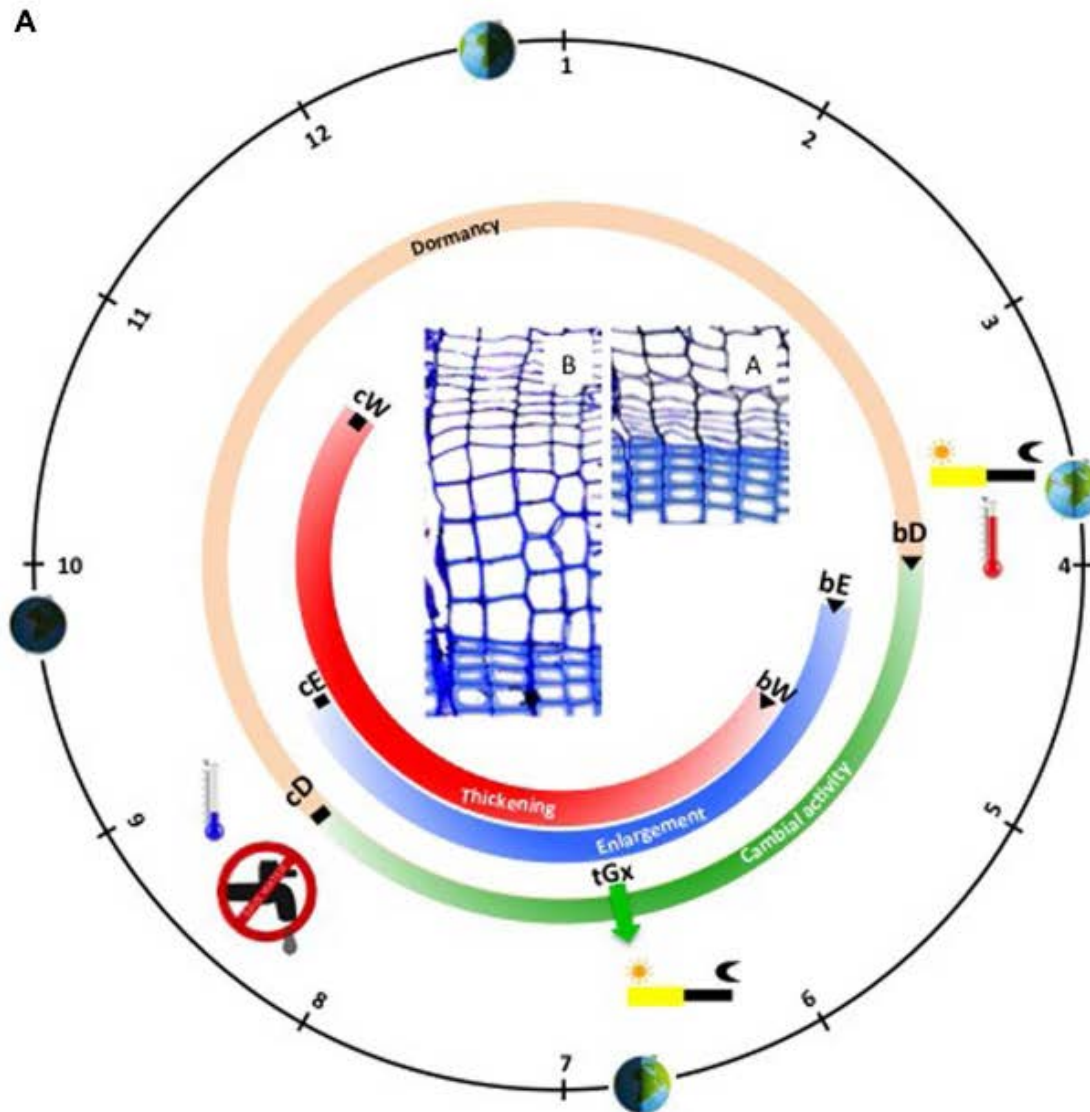

**B**

Code	Phenological event	Environmental cue
bD	Onset of cambial cell division	Warm temperature Chilling Photoperiod
bE	Onset of xylem cell enlargement	
bW	Onset of secondary cell wall deposition	
tGx	Occurrence of maximal growth	Photoperiod
cD	Cessation of cambial cell division	Low temperature Water stress Photoperiod?
cE	Cessation of xylem cell enlargement	?
cW	Cessation of secondary cell wall deposition	Temperature?

# Dynamique de la mise en place des différentes couches de la paroi cellulaire

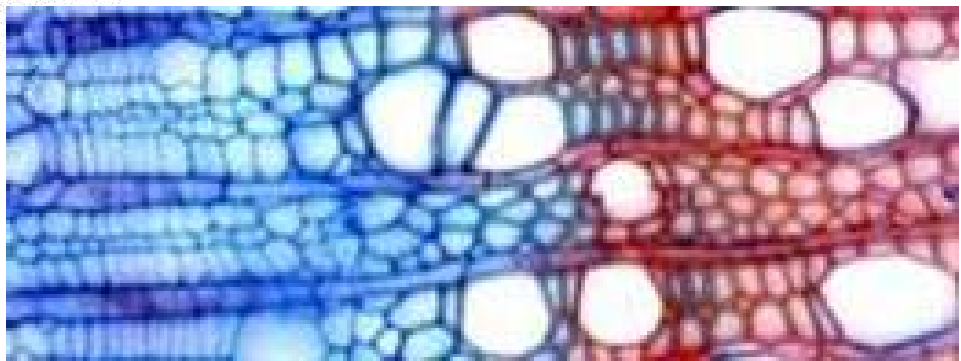
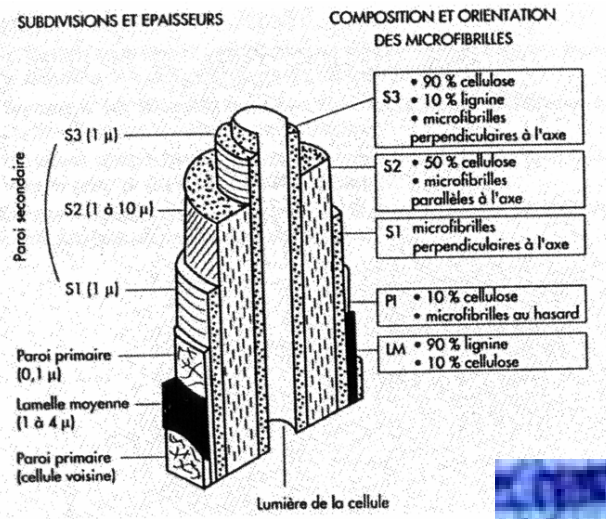

*Cambium* → *Mise en place des couches* → *Parois matures*

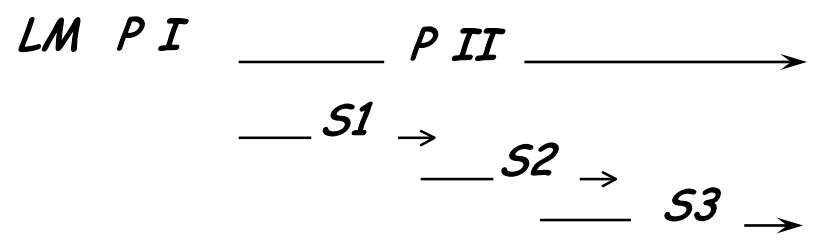

# Orientation des microfibrilles de cellulose dans la paroi secondaire

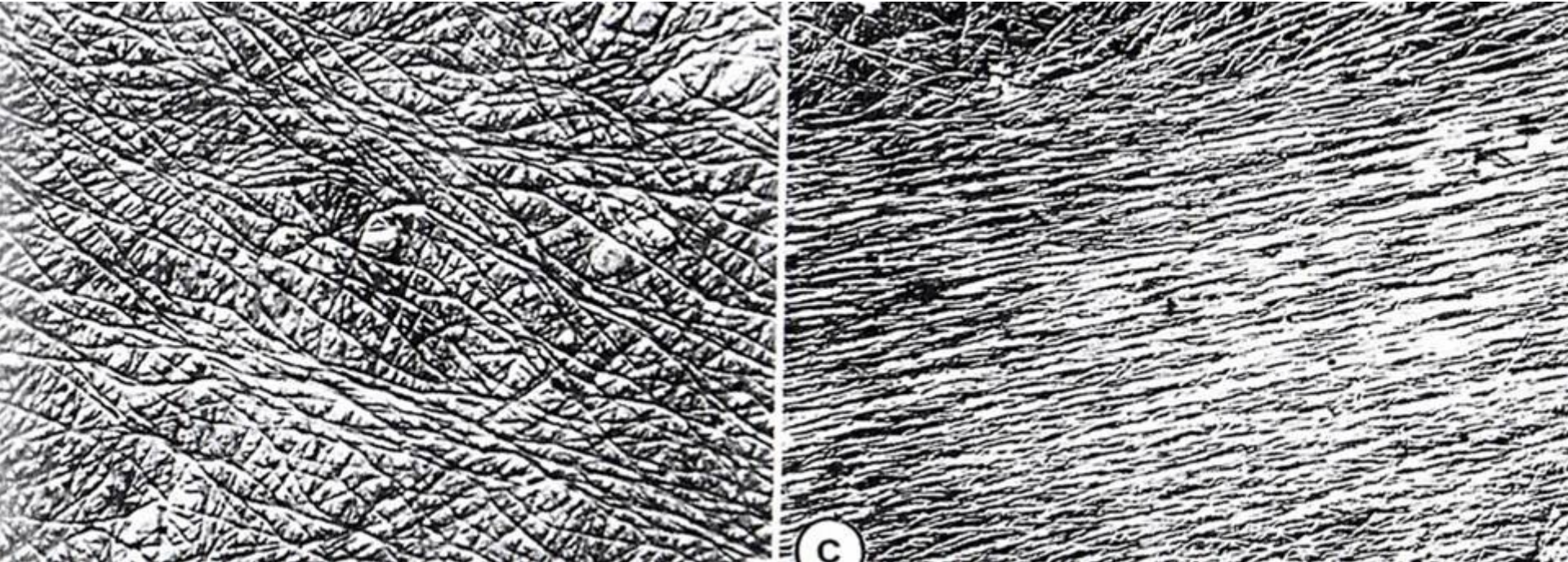

Gunning & Steer, 1975

**Paroi primaire : au hasard**

**Paroi secondaire S2 : parallèle**

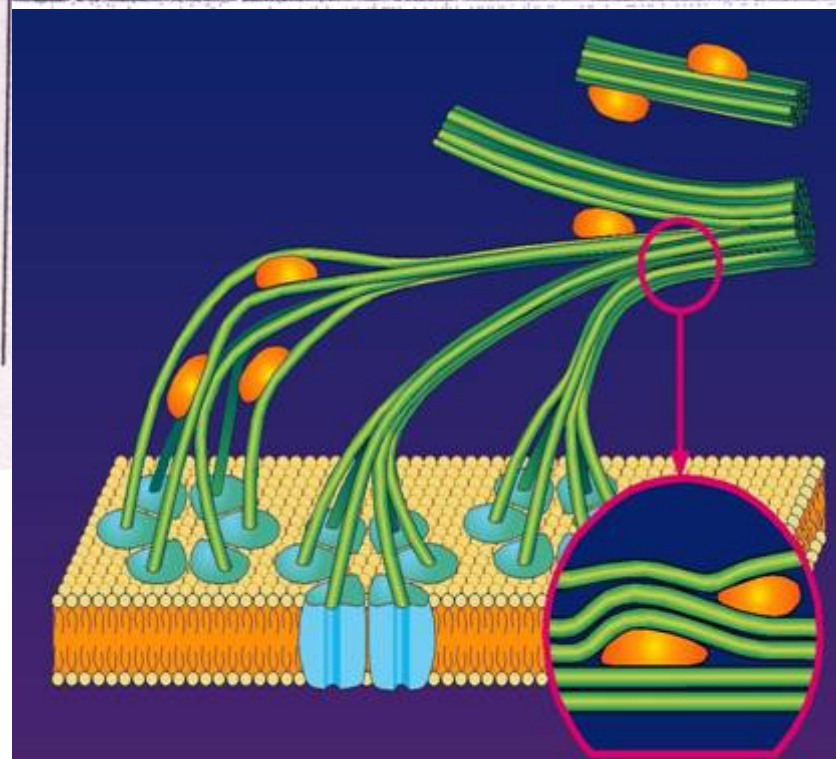
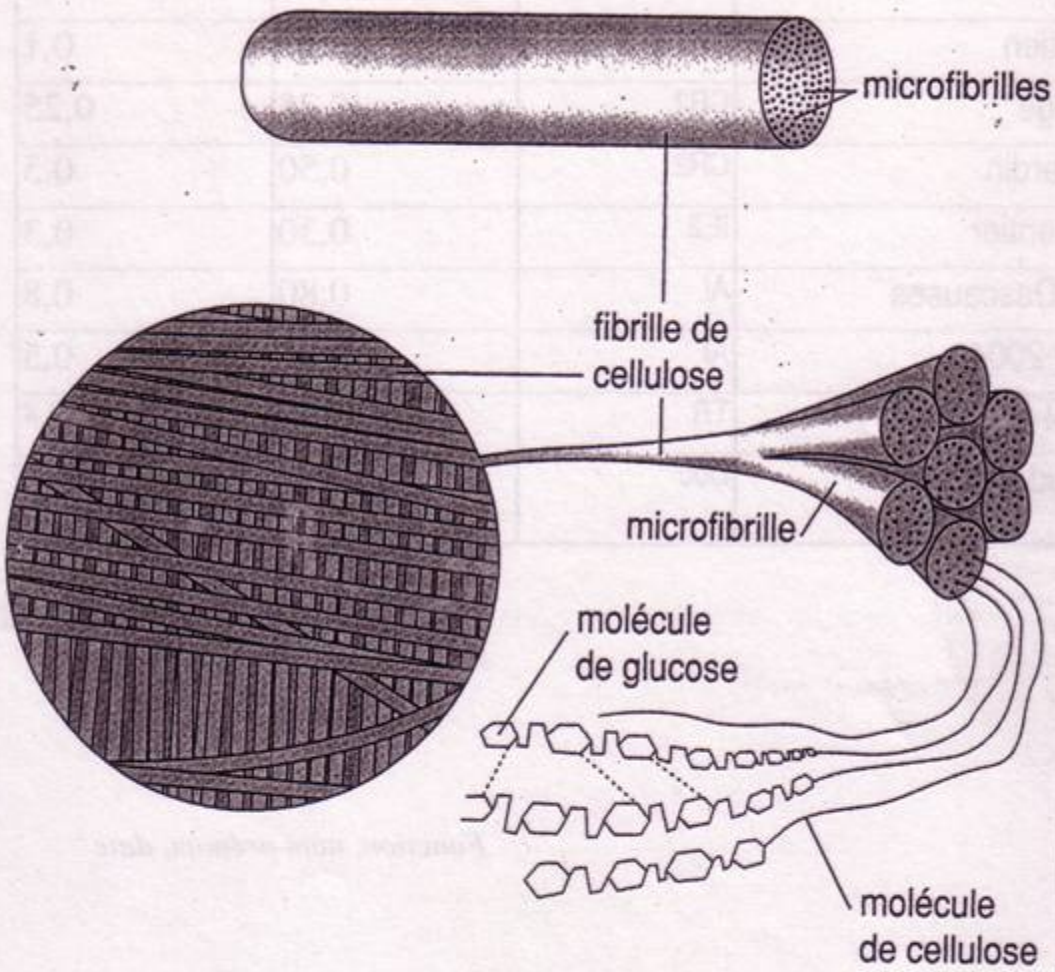



# Lignines

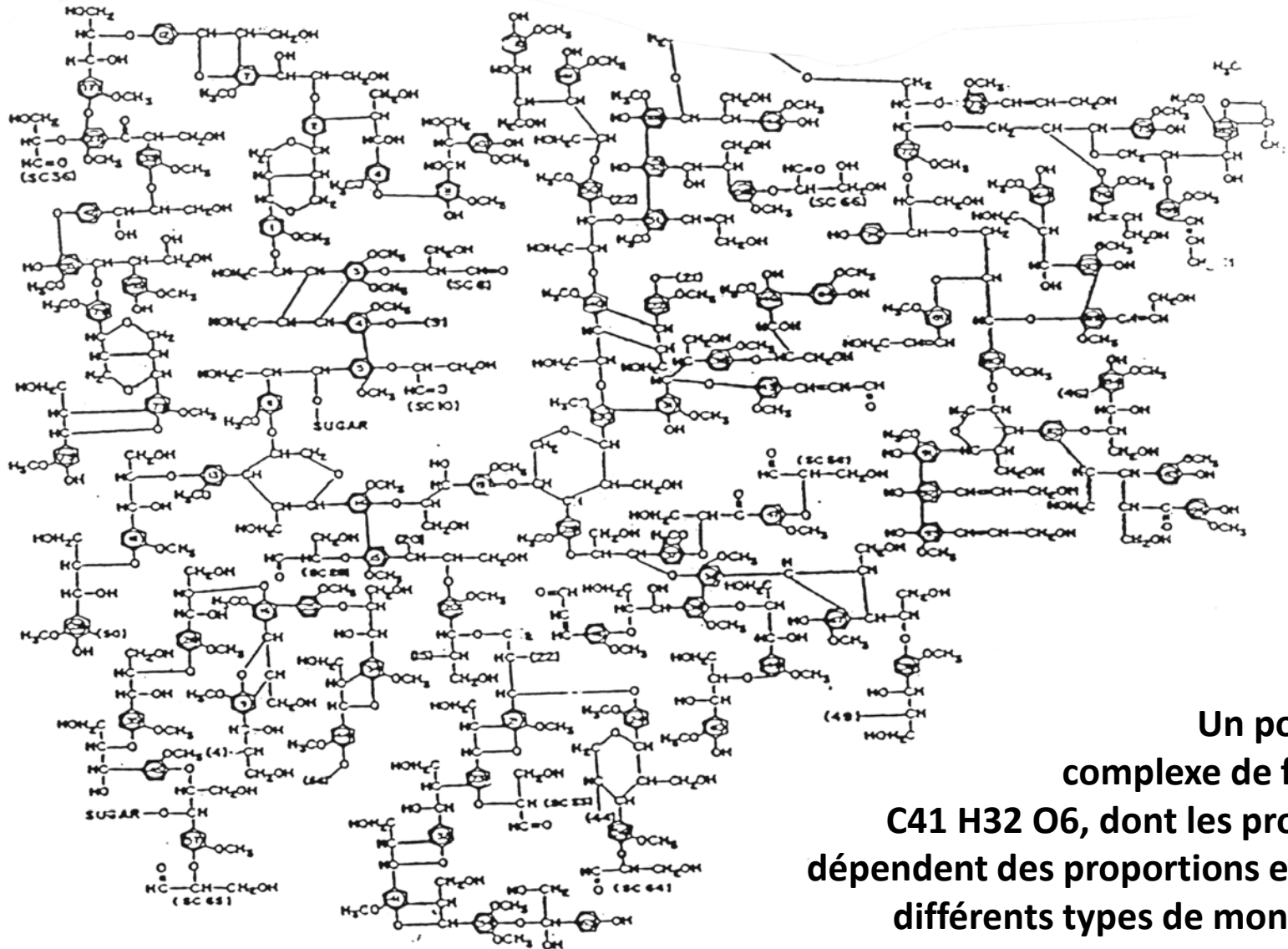

Un polymère  
complexe de formule  
 $C_{41}H_{32}O_6$ , dont les propriétés  
dépendent des proportions entre les  
différents types de monomères

# Lignines

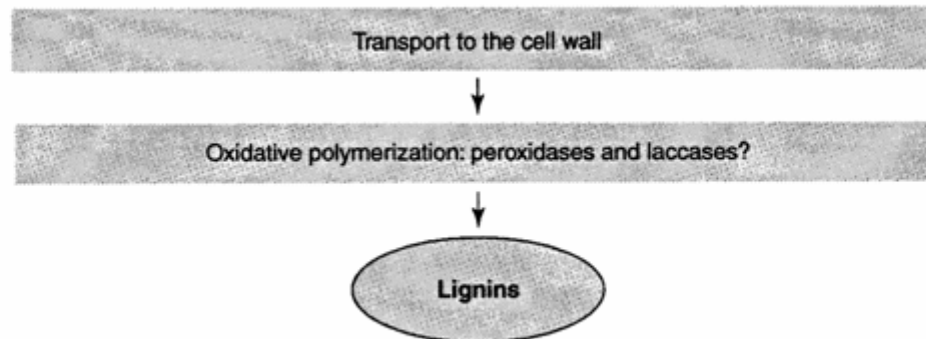
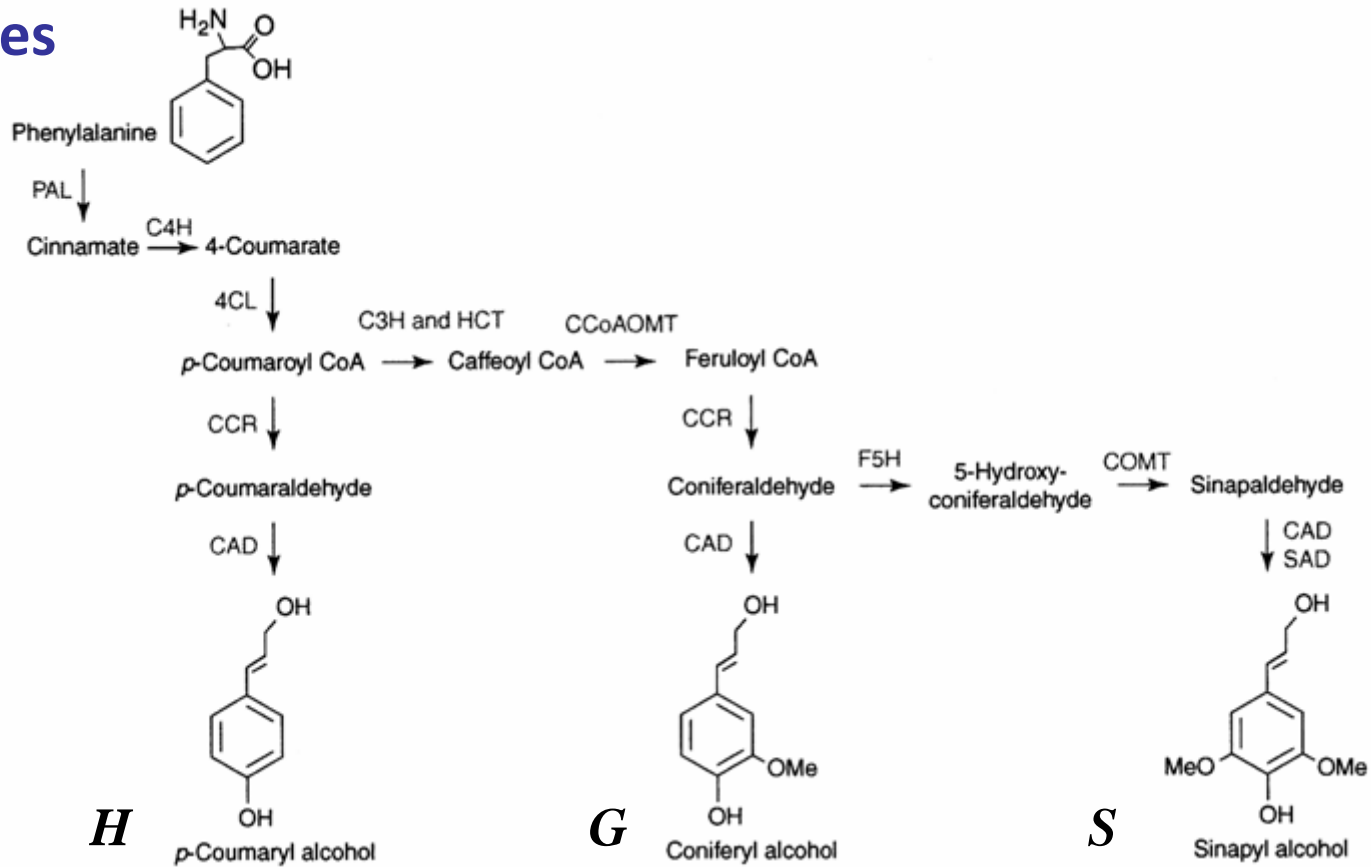

# Dynamique de mise en place des polymères pariétaux

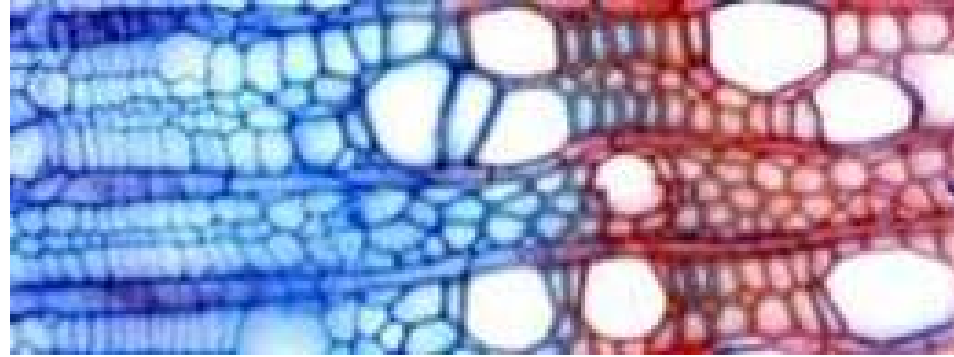

**Cambium**                      **Dépôt des composés pariétaux**                      **Parois matures**

LM : lamelle moyenne,  
 P I : paroi primaire,  
 P II : paroi secondaire,  
 S1, S2, S3 : couches de la  
 paroi secondaire,  
 H: alcool p-Coumarylique,  
 G: alcool coniferylique  
 S: alcool sinapylique,  
 (Terashima et al, 1993)

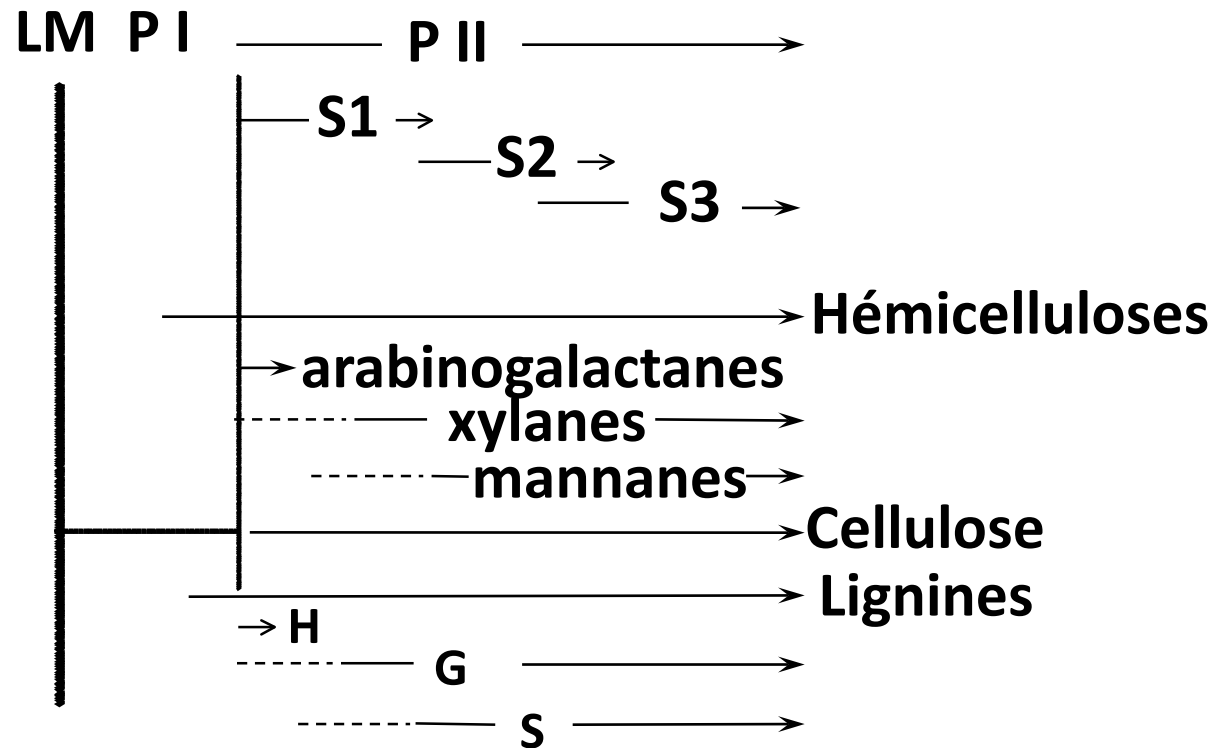

A grayscale micrograph of a wood cross-section. The image shows a complex network of cells and vessels. Large, circular vessels with thick, multi-layered walls are prominent. Smaller, more irregularly shaped cells with distinct cell walls are interspersed between the larger vessels. The overall structure is highly organized and shows the characteristic patterns of wood anatomy.

# Mécanismes moléculaires de la formation du bois

A grayscale micrograph of plant tissue, likely a cross-section of a stem or root. The image shows large, polygonal cells with thick, dark cell walls. The central regions of these cells are lighter and contain large, dark, irregularly shaped structures, possibly nuclei or large vacuoles. The overall texture is highly detailed, showing the intricate structure of the plant cells.

**Stratégies / Modèles d'étude /  
Approches**

# Arabidopsis as a model plant to study wood formation

- Wood formation in the hypocotyl of short-day grown Arabidopsis (c)
- SCW in interfascicular fibers of floral stems
- Differentiation of tracheary element in cell culture

Poplar stem

Arabidopsis hypocotyl

(b)

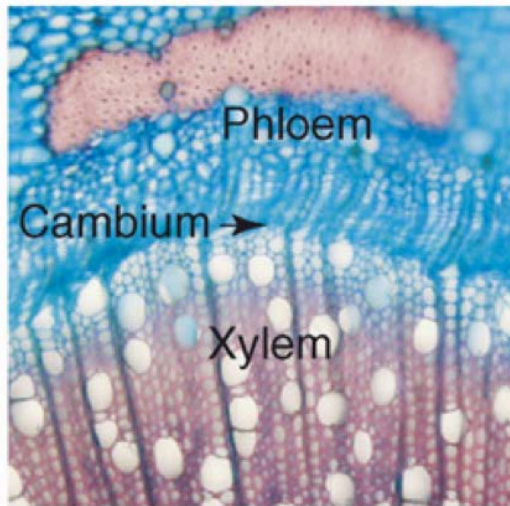

200  $\mu$ m

(c)

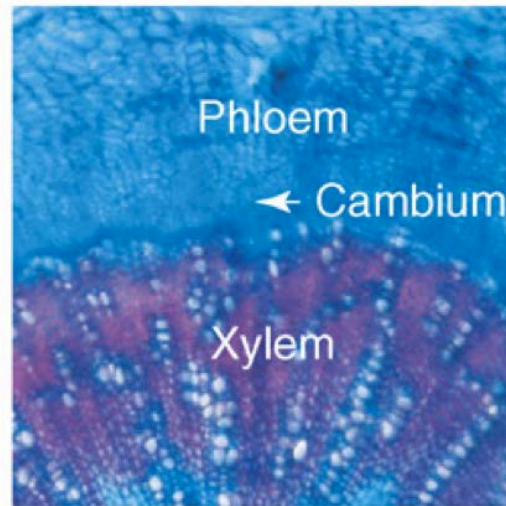

200  $\mu$ m

(d)



100  $\mu$ m

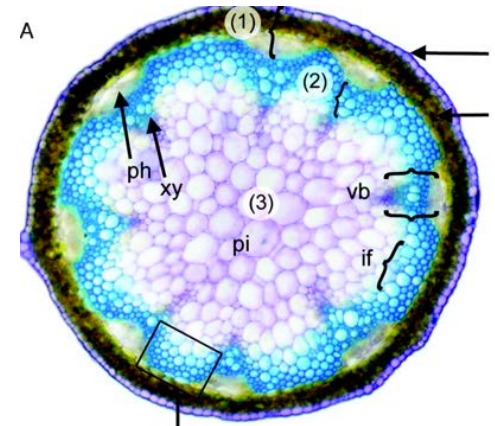

## Tree resources for the study wood formation

- *Populus* spp., *Pinus* spp. and *Eucalyptus* spp., *Robinia pseudoacacia*, Walnut
- Reaction wood has received a lot of attention (*Populus*, *Pinus*, *eucalyptus*)
- Heartwood formation was studied preferentially on Walnut and Black locust

-----

Populus was the first tree genome sequenced (2006), and eucalyptus recently (2010) - see <http://www.phytozome.net>

Populus became a “model tree” for Genomics

# Le peuplier : espèce d'intérêt économique et espèce modèle en biologie forestière

Peupleraies cultivées

2% de la surface forestière

3<sup>ème</sup> essence feuillue en volume de bois récolté



Vitesse de croissance rapide

Multiplication végétative aisée par bouturage

## Transformation génétique

Populations naturelles, d'amélioration, cartes génétiques

Nombreuses données de génomique  
(plus de 400 000 EST pour le genre *Populus*)



Génome séquencé (*Populus trichocarpa*, Nisqually-1)  
Autres génotypes séquencés (*P. trichocarpa*, *P. nigra*)

Utilisations actuelles : déroulage (emballages légers),  
tranchage (contreplaqué)

Bois énergie

En développement : bioéthanol

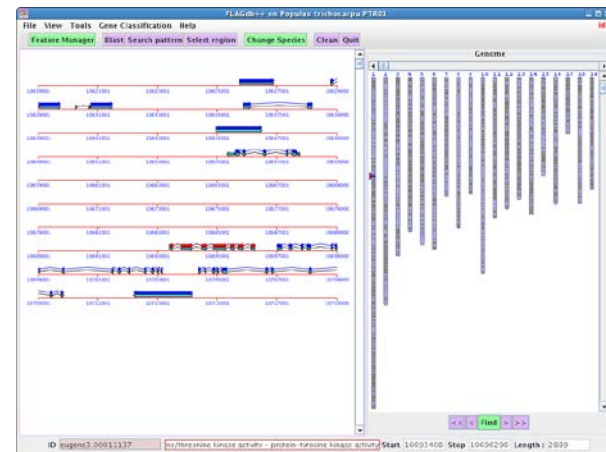



# Functional genomics: objectives and tools

---

## Functional genomics objectives:

- Inventory of gene (proteins, RNAs) functions and interactions
- high-throughput methods rather than “gene-by-gene” approach
- Links between genes and phenotype

## Functional genomics tools:

- Characterization of mutants (nearly absent in tree species)
  - **Characterization of transgenic plants**
  - “omics” (transcriptomics, proteomics, metabolomics, Chip-seq, degradome...)
- and combinations of these tools

# Approche génomique de la formation du bois

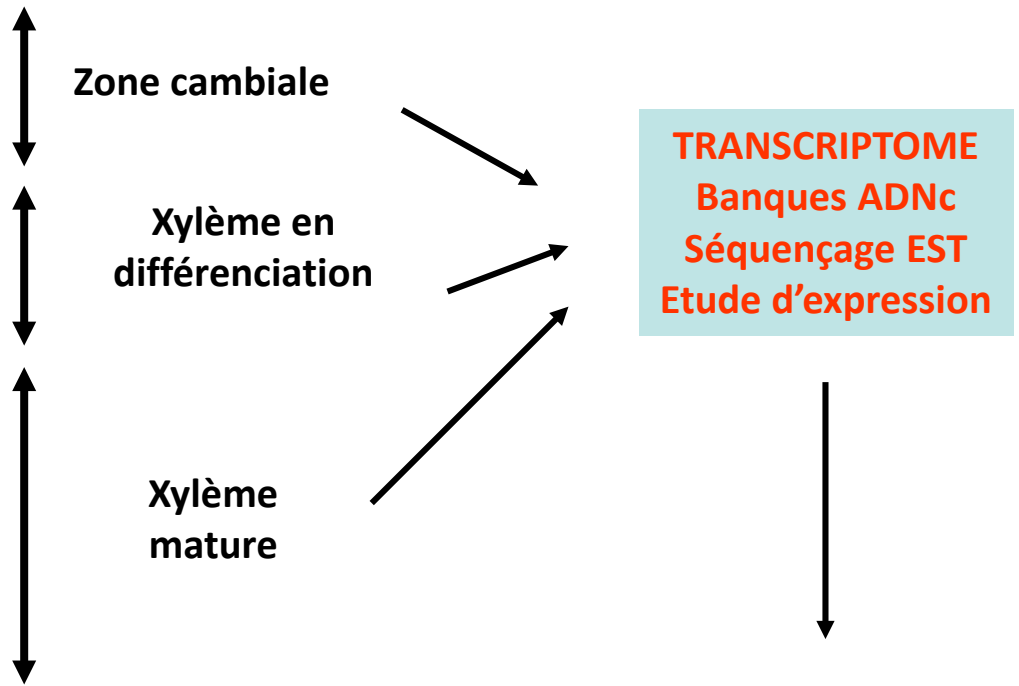
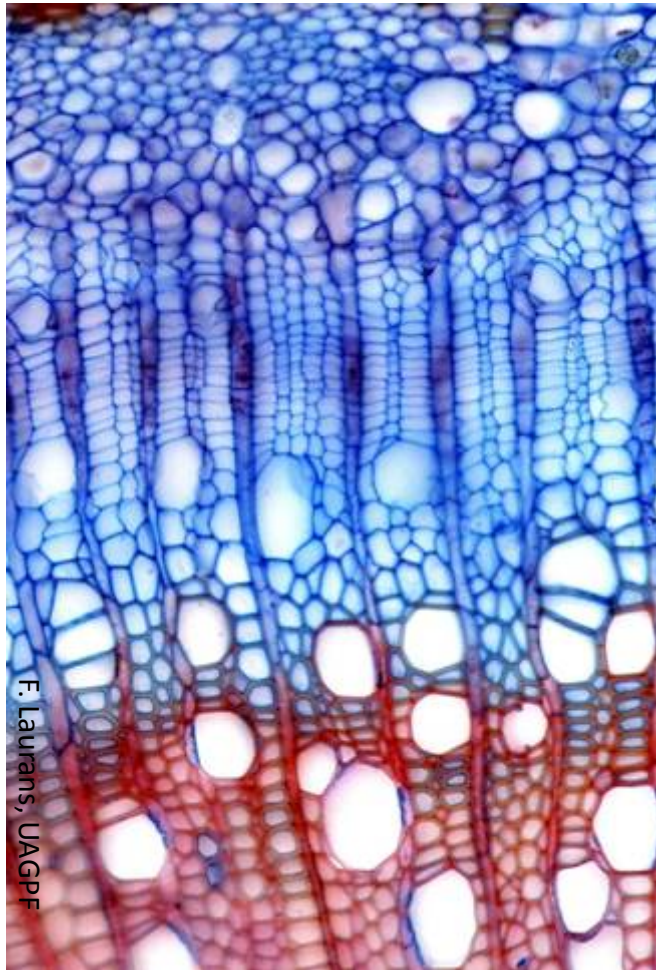

Catalogue de gènes exprimés

Quelle(s) fonction(s)?

CT tige de Peuplier - Coloration Safranine/Bleu Astra

# Intérêt de l'outil transgénèse pour étudier la fonction des gènes

Modification de l'expression d'un gène  
(surexpression, silencing, ciblée ou non dans un tissu particulier)

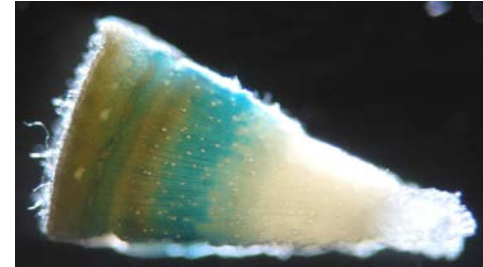

Modification du phénotype



Fonction du gène (?)

# Transformation génétique du peuplier *via Agrobacterium tumefaciens* (Leplé et al., 1992)

*P. tremula x P. alba*, clone INRA 717-1B4



2 isopentenyl adenine (CK)  
Acide Naphtalène Acétique (AUX)

Thidiazuron (CK)  
Cefotaxime (ANT)  
Ticarpén (ANT)  
Agent de sélection

Cefotaxime (ANT)  
Ticarpén (ANT)  
Agent de sélection

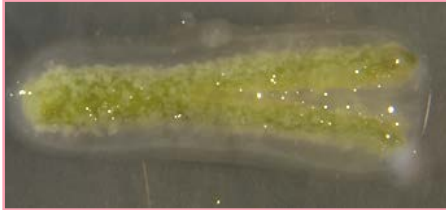
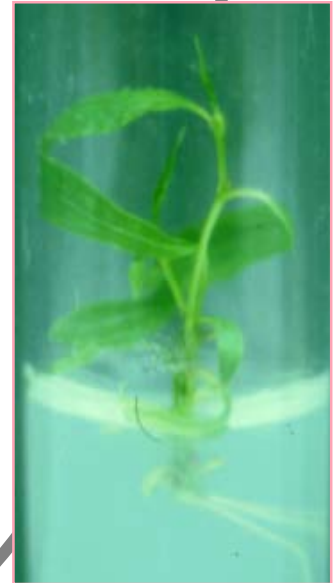
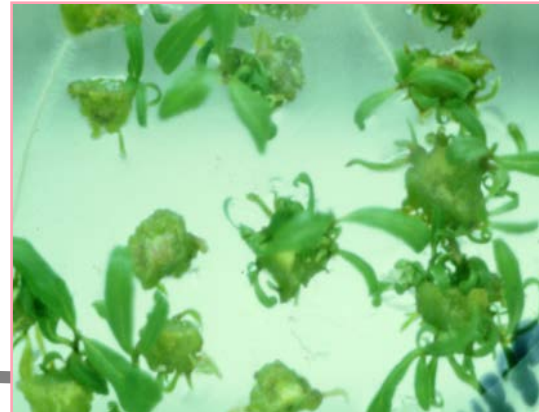

# Gene expression patterning along the developmental stages of xylogenesis

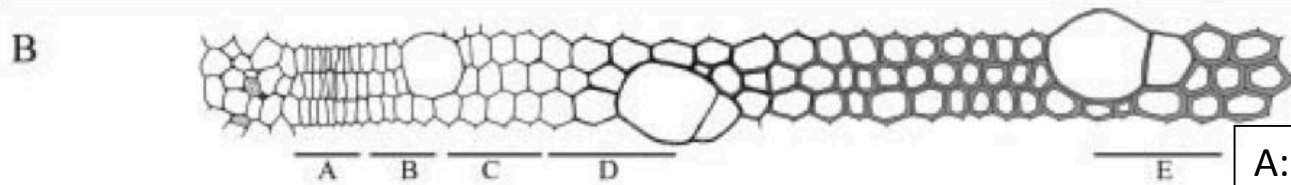
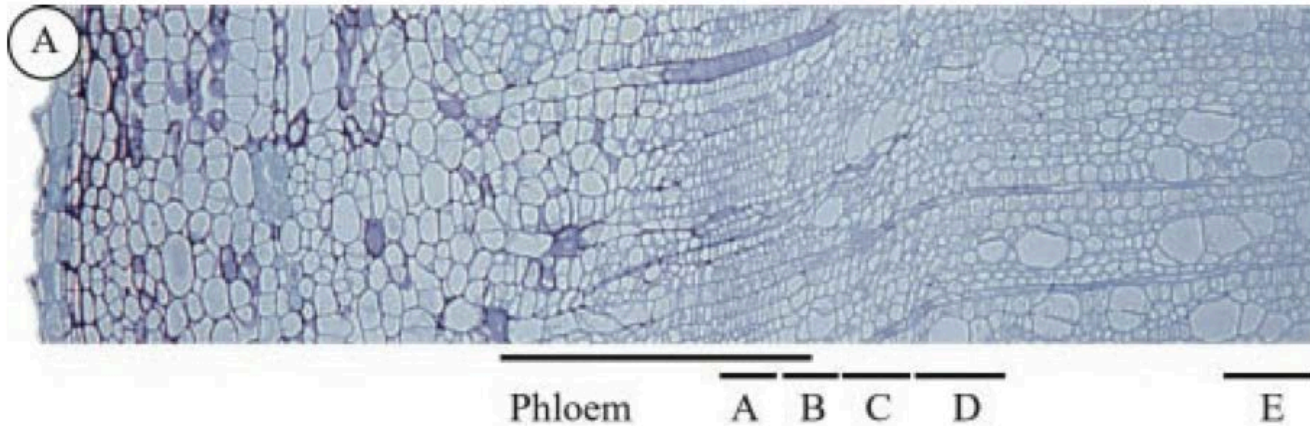

A: meristematic cells  
 B: early expansion  
 C: late expansion  
 D: secondary wall formation  
 E: late cell maturation.

# Gene expression patterning along the developmental stages of xylogenesis

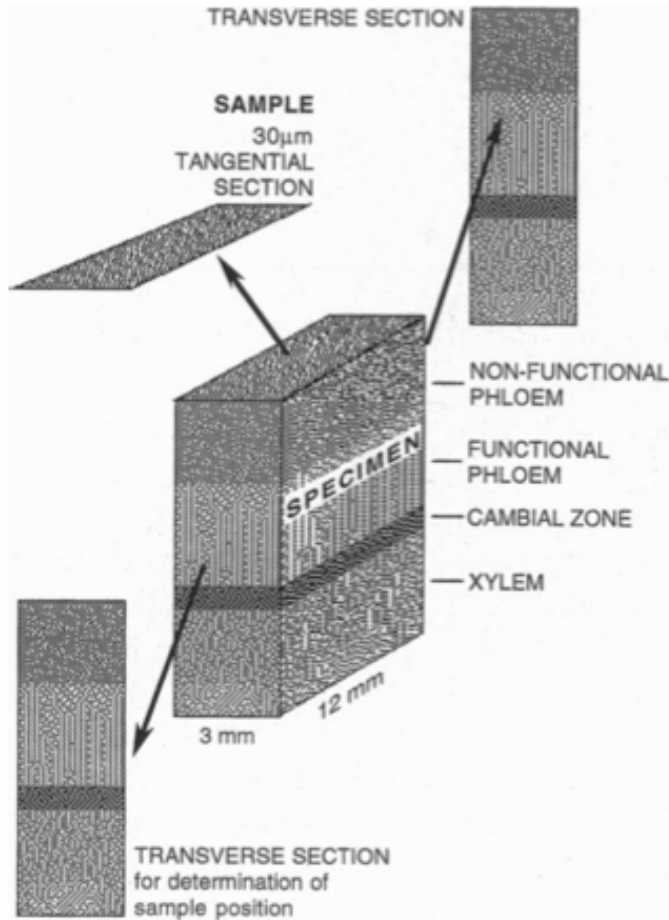

Cryosectioning of the vascular cambium

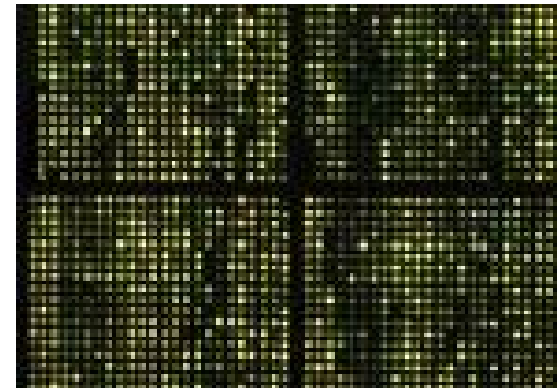

Microarray based on a unigene set of 2,995 cDNA clones

# Hierarchical cluster analysis of 1,791 selected genes with differential expression in the tissues

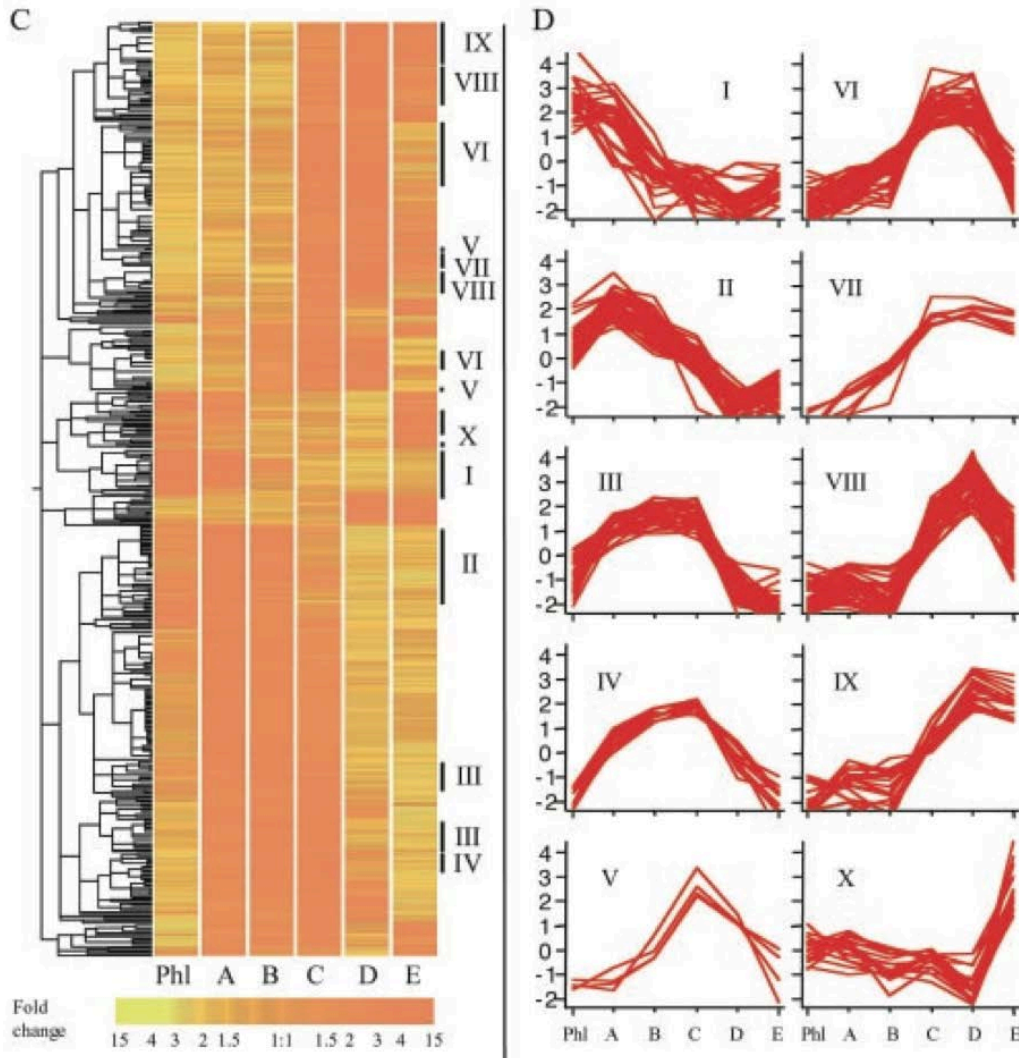

A & B: cell fate and cell identity (ATHB-8 & ATHB-9 homologues)

A-C:

- cell-cycle machinery  
Cyclins, cyclin-dependent kinases (still expressed in late expansion zone)
- Cell expansion (pectin metabolism, protein synthesis and 6 MYBs transcription factors)

C-E: biosynthesis of SCW

Tubulins, 2 CesA, KOR, polygalacturonase (pectins remodelling), Glycosyl-transferases, a specific SCW UDP glucose dehydrogenase (hemicellulose synthesis)

# Lignin biosynthesis

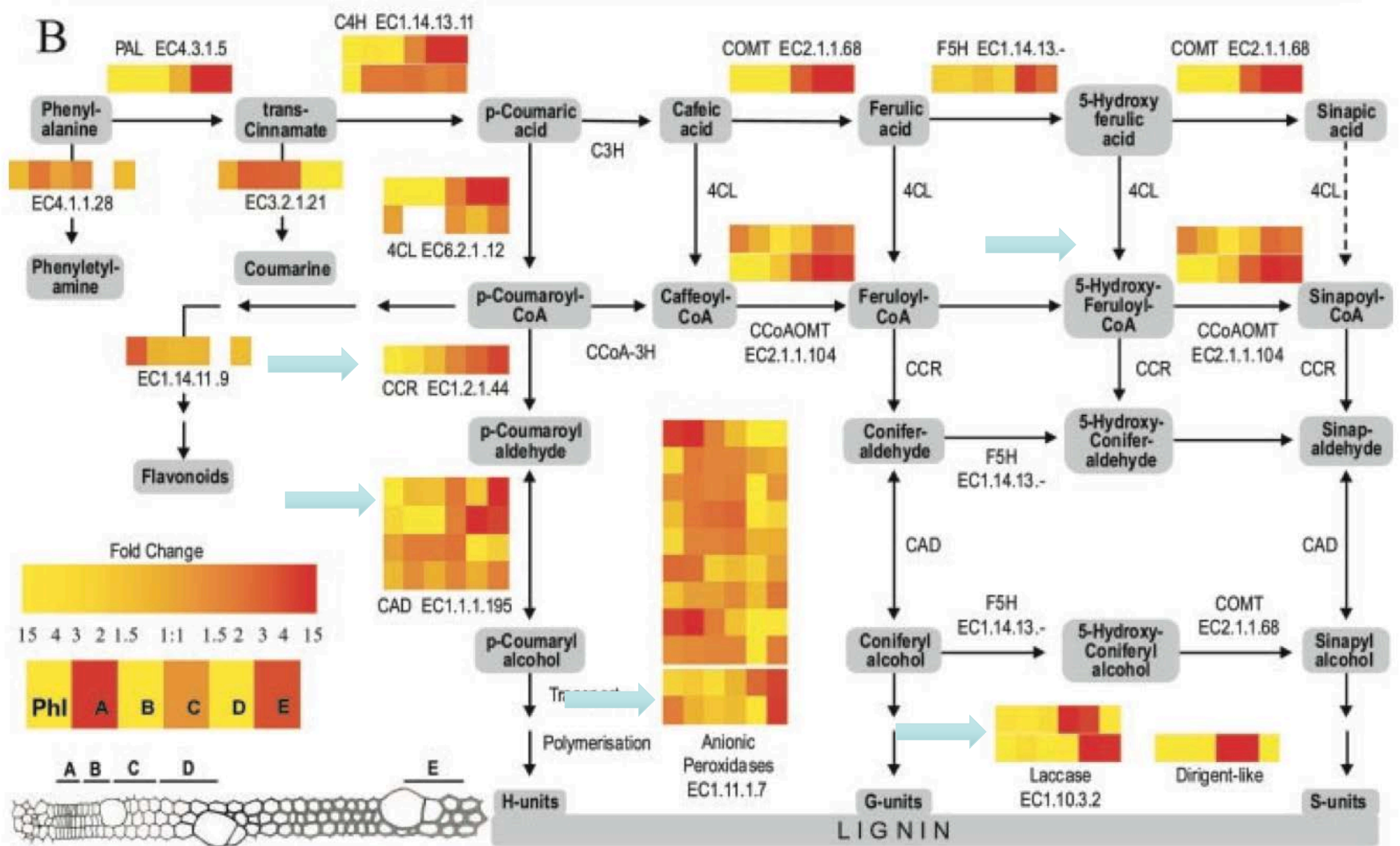



A light micrograph of a plant stem cross-section showing several vascular bundles. Each bundle has a distinct vascular cambium, which is a layer of cells responsible for secondary growth. The cambium is visible as a thin, dark line within each bundle, separating the primary xylem from the secondary xylem. The secondary xylem shows characteristic growth rings. The pith is visible at the center, and the cortex is at the periphery.

## Contrôle de l'activité cambiale

# Regulation of cambium activity and cell proliferation

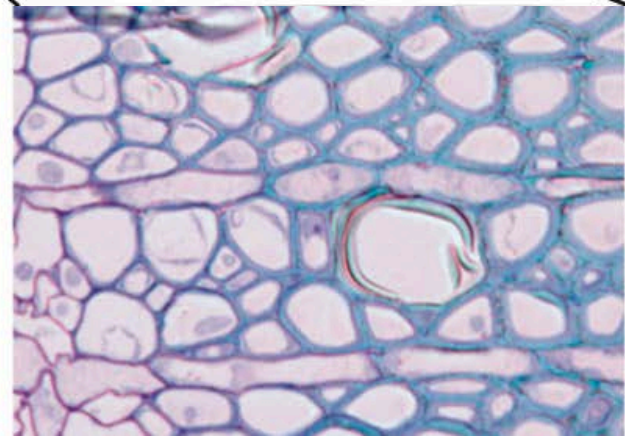
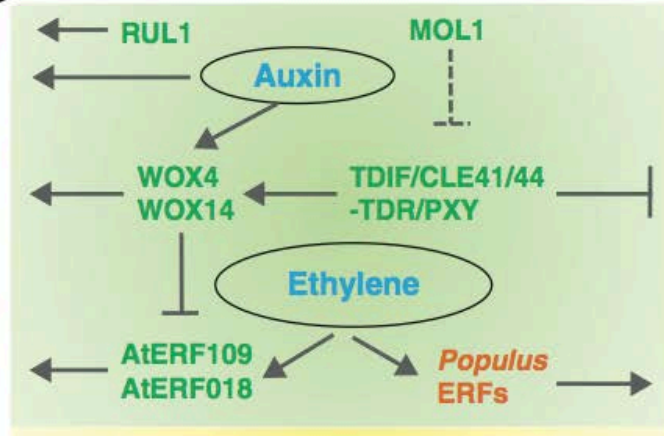
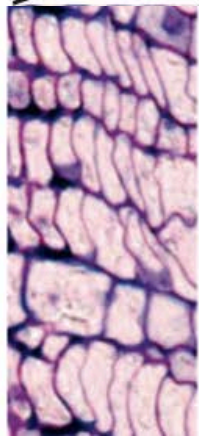
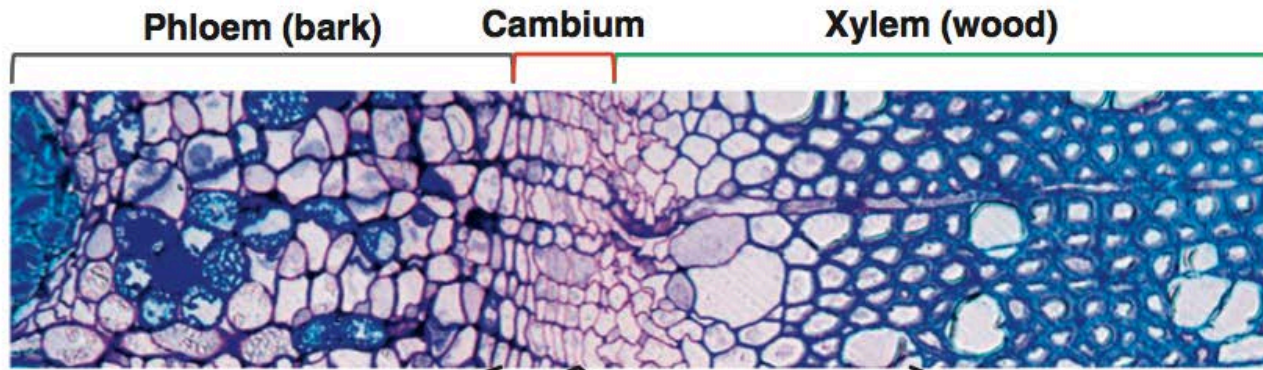

Cambium maintenance

Xylem differentiation

## Regulation of cambium activity and cell proliferation

----

### The TDIF/CLE41/CLE44-TDR/PXY-WOX4 signaling pathway

- TDIF, processed from the translated products of CLE41/ CLE44 in Arabidopsis, is produced in the phloem; it interacts with its receptor, the receptor-like kinase TDR/PXY, which is expressed in (pro)- cambium.
- WOX4 & WOX14: WUSCHEL HOMEODOMAIN RELATED genes WOX14, acts redundantly to regulate cambial cell proliferation
- MOL1 and RUL1 are RLKs and potential partners of TDR/PXY. MOL1 acts as a repressor and RUL1 as an activator of secondary growth.

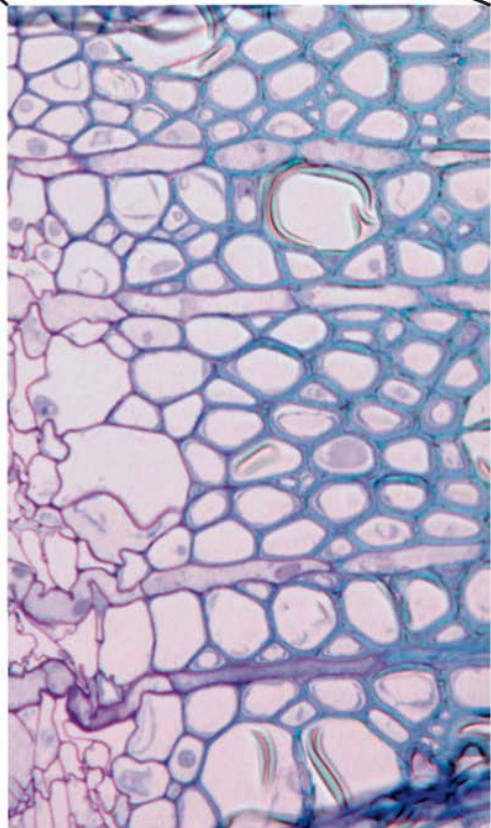
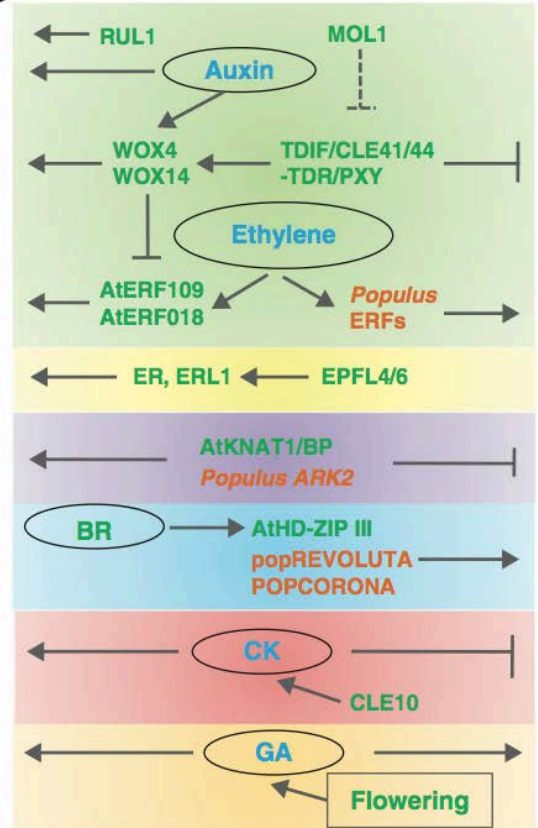
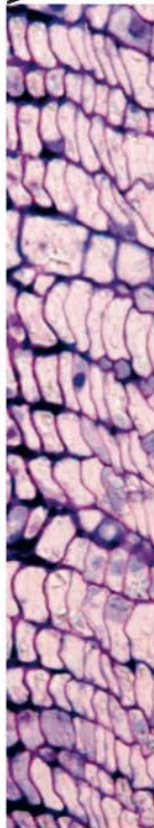
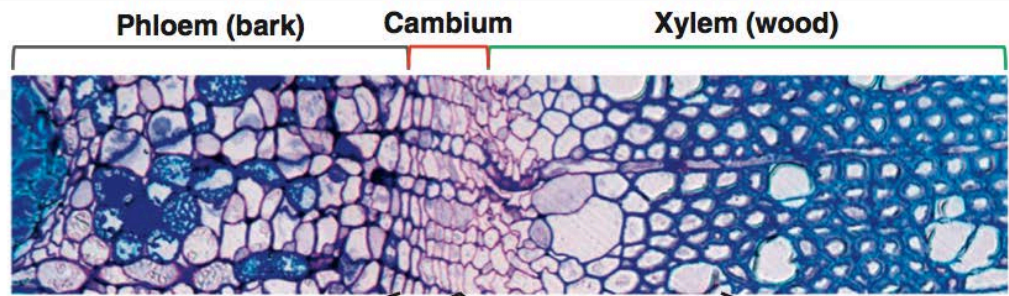

**Cambium maintenance**

**Xylem differentiation**

Arabidopsis  
Populus  
both

## Regulation of cambium activity and cell proliferation

- Class I KNOX TFs are important in maintaining the meristematic activity in the shoot apical meristem of Arabidopsis. Arabidopsis BP/KNAT1 and its ortholog ARK2 in populus, when overexpressed, promote the expansion of the cambium region and the inhibition of xylem differentiation.
- In the tdr/pxy Arabidopsis mutant background, a double mutant of ERF109 and ERF018 shows reduced secondary growth while an ethylene over-producing mutant displays enhanced growth
- In populus several ERFs have been identified which modify secondary growth, wood properties and tension wood formation

## Regulation of xylem specification and cell expansion

- HDZIPIII in *Populus*. Knockdown of POPCORONA (orthologue of Arabidopsis CNA/AtHB15) causes abnormal lignification of pith cells, while overexpression of miRNA-resistant POPCORONA results in delayed lignification of xylem and phloem fibers. On the other hand, when a micro-RNA-resistant form of popREVOLUTA (ortholog of Arabidopsis REV/IFL1) was overexpressed, ectopic layers of cambium with reversed polarity were formed within cortical parenchyma. popREVOLUTA plays a fundamental role in the initiation of the cambium and in regulating the patterning of secondary vascular tissues.
- auxin found in the cambium. a concerted role of PXY and WOX4 in auxin-dependent cambium stimulation
- gibberellic acid is observed in the differentiating xylem cells of tree stems. When GA levels are increased by over-expressing GA-20 oxidase in *Populus*, an increase in both the number and length of xylem fibers is observed, indicating that GA promotes both cell division and xylem elongation
- NAC master regulators (VND6, VND7, NST1 and SND1/NST3) switch on the xylem differentiation program largely by inducing the expression of MYB46 and MYB83

# The *Populus* ARBORKNOX1 homeodomain transcription factor regulates woody growth through binding to evolutionarily conserved target genes of diverse function

Lijun Liu<sup>1</sup>, Matthew Zinkgraf<sup>1</sup>, H. Earl Petzold<sup>2</sup>, Eric P. Beers<sup>2</sup>, Vladimir Filkov<sup>3</sup> and Andrew Groover<sup>1,4</sup>

<sup>1</sup>Pacific Southwest Research Station, USDA Forest Service, Davis, CA 95618, USA; <sup>2</sup>Department of Horticulture, Virginia Tech, Blacksburg, VA 24061, USA; <sup>3</sup>Department of Computer Science, University of California, Davis, CA 95618, USA; <sup>4</sup>Department of Plant Biology, University of California, Davis, CA 95618, USA

The class I KNOX homeodomain transcription factor ARBORKNOX1 (ARK1) is a key regulator of vascular cambium maintenance and cell differentiation in *Populus*.

Identification of ARK ChIP- binding loci at the genome level by ChIP-SEQ technology : more than 13 000 putative targets

ARK1 binds to thousands of loci which are highly enriched proximal to the transcriptional start sites of genes of diverse functions. *However, only a small portion of ARK1 target genes are significantly differentially expressed in an ARK1 over-expression mutant.*

# Le CHIP – SEQ permet d'identifier les cibles de facteurs de transcription au niveau génome entier

ChIP-SEQ = Séquençage haut-débit de fragments d'ADN issus de ChIP

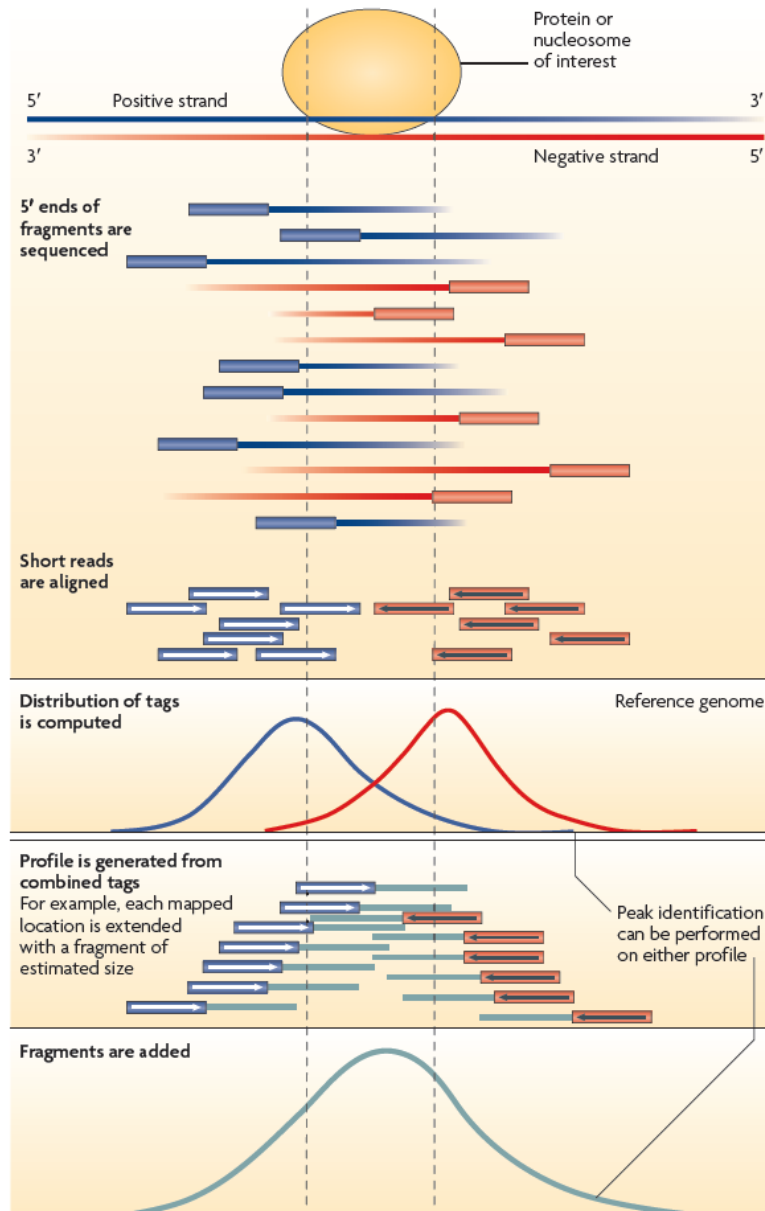

Fragments ADN immunoprécipités (200 pb) séquencés en 5'

Alignement des tags de 36 pb sur le génome de référence

Détection des sites d'enrichissement

## Intérêts :

- Permet de cartographier au niveau du génome les sites d'interaction entre ADN et FT (**précision de 10 à 50 pb**, selon profondeur de séquençage)
- Ne requiert « que » **5 ng** d'ADN
- Contraintes : nécessite d'avoir un génome de référence séquencé



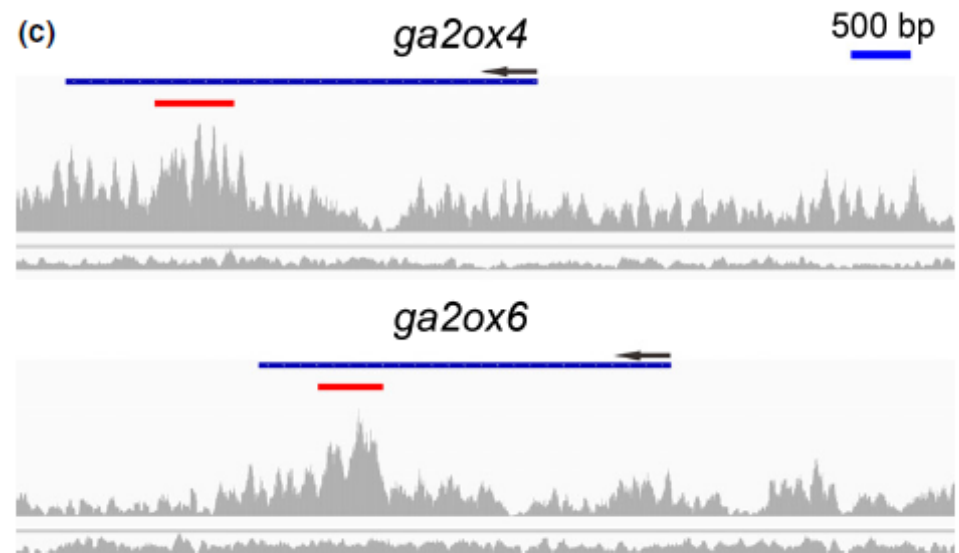
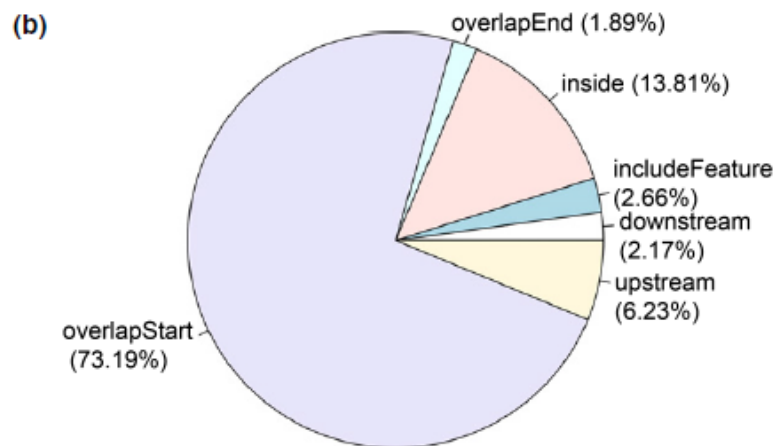
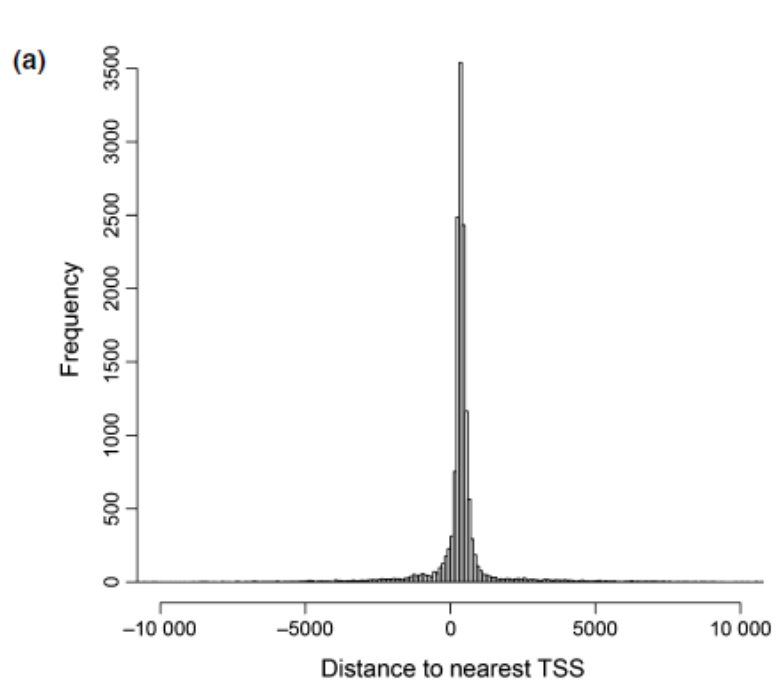

**Fig. 2** Overview of ARBORKNOX1 (ARK1) binding loci in the *Populus* genome. (a) ARK1 binding loci are highly enriched in the promoter regions around the transcriptional start site (TSS) of genes. (b) ARK1 binding loci relative to gene features. (c) Significant ARK1 chromatin immunoprecipitation sequencing (ChIP-seq) peaks associated with two Gibberellin 2-oxidase (*ga2ox*) genes, homologs of which were characterized as direct targets of the class I KNOX protein KN1 in maize. For each gene, tracks from top to bottom represent the gene size and orientation, ARK1 ChIP-seq peak called by *MACS2* (red bars), mapped reads of the pooled ARK1 ChIP-seq, and mapped reads of the input control used to subtract background differences in read mapping efficiencies from ChIP-peak calling, respectively. The black arrow indicates the gene TSS and orientation.

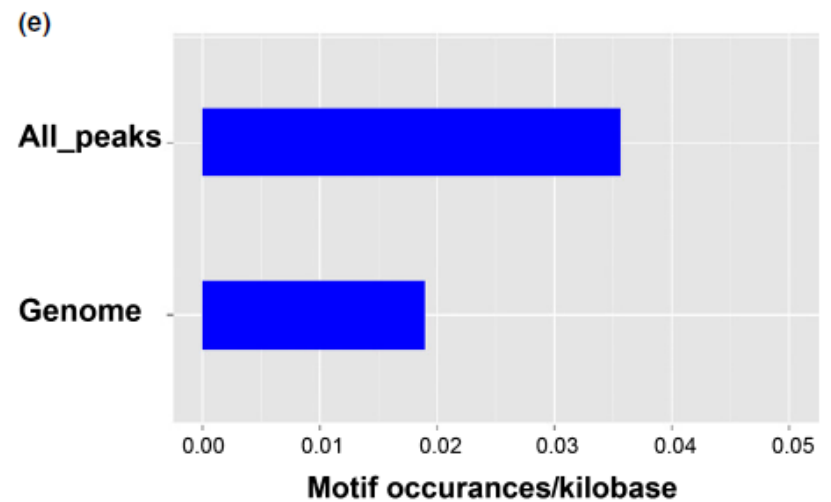
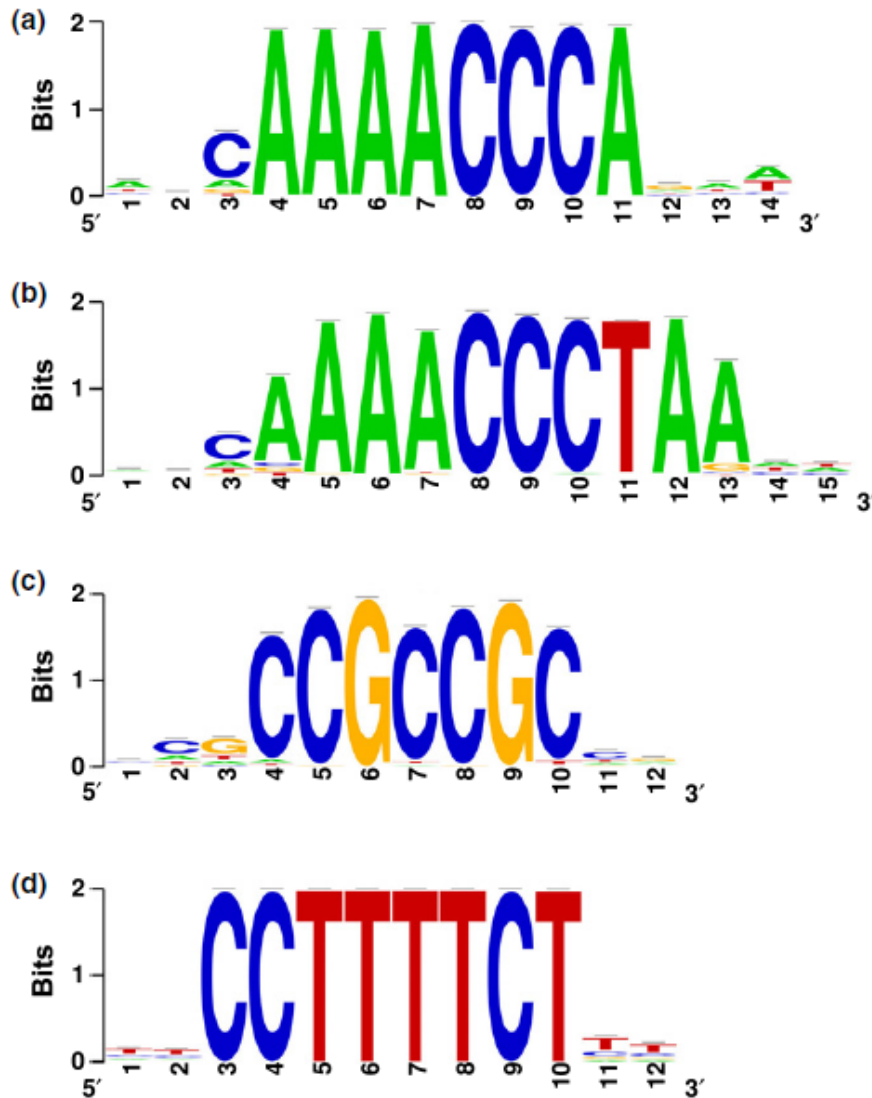

Fig. 3 Putative ARBORKNOX1 (ARK1) binding motifs. (a–d) Four high-confidence putative ARK1 binding motifs identified by different algorithms. (a) Positions\_6nt\_m1 (significance score = 300.00); (b) positions\_6nt\_m3 (significance score = 300.00); (c) positions\_6nt\_m5 (significance score = 300.00); (d) positions\_6nt\_m1 (significance score = 218.25). (e) Occurrence of a previously identified KNOX protein binding motif among ARK1 binding loci compared to the whole genome.

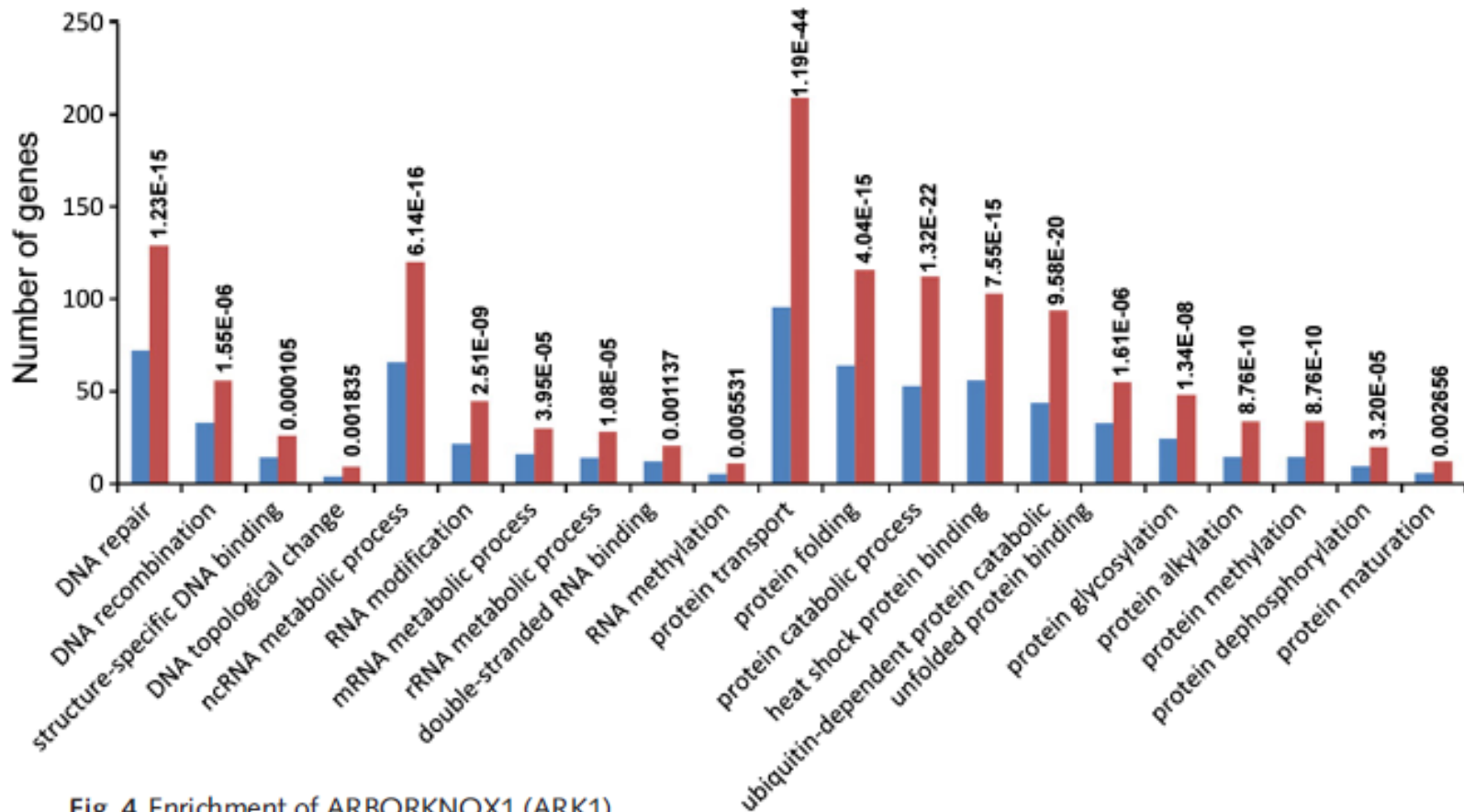
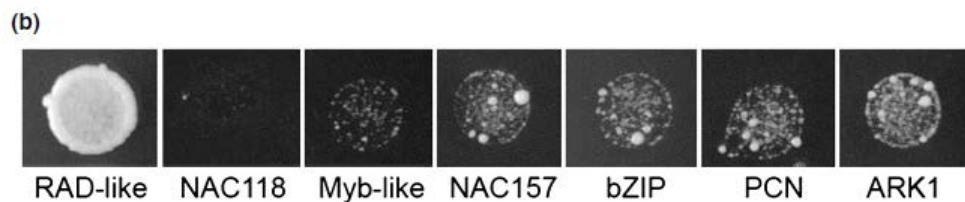
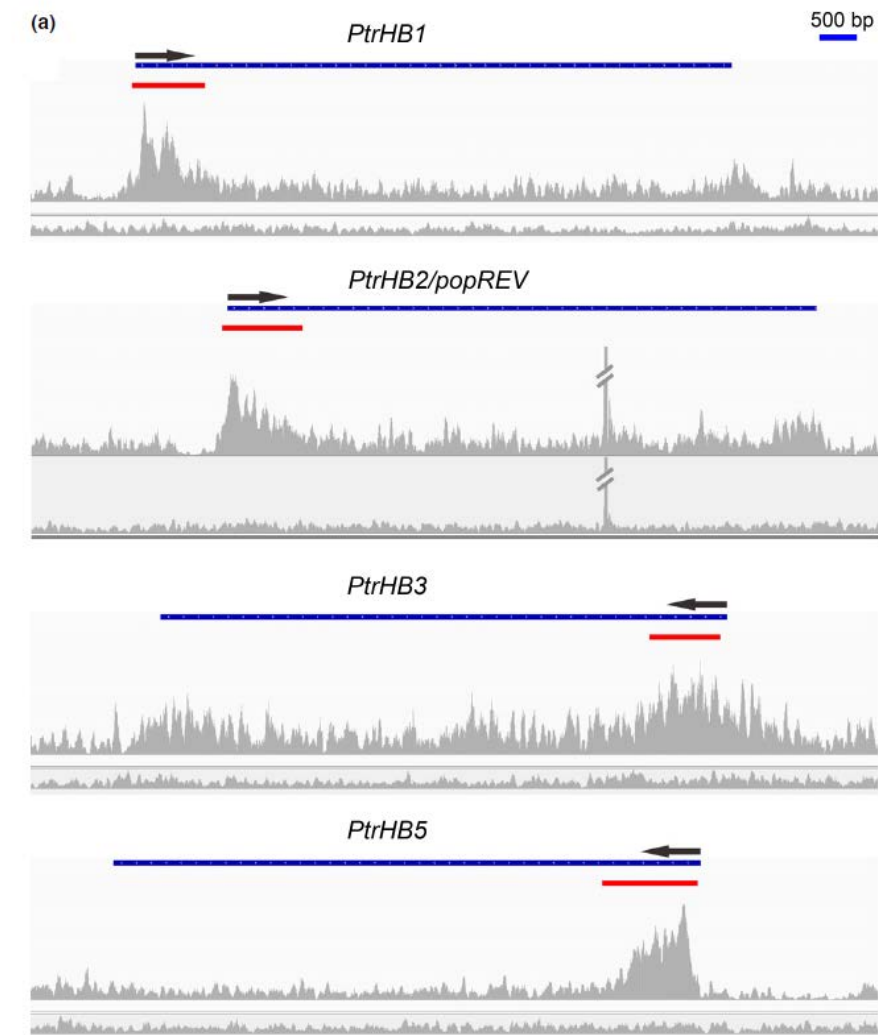
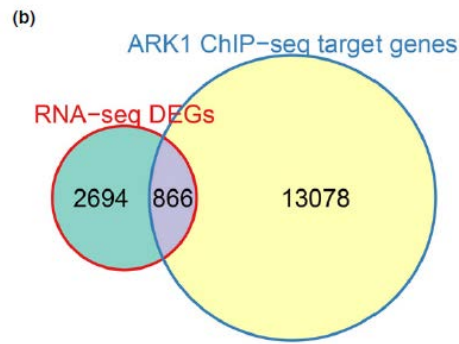

Fig. 4 Enrichment of ARBORKNOX1 (ARK1) target genes in gene ontology (GO) categories related to DNA, RNA, and protein catabolism. Numbers at the top of each histogram are *P*-values of the GO category enrichment. 'Expected' (blue bars) and 'Observed' (red bars) represent the numbers of expected and observed ARK1 chromatin immunoprecipitation sequencing (ChIP-seq) target genes in each GO category.



**Fig. 5** ARBORKNOX1 (ARK1) binding to promoters of class III *HD ZIP* genes in *Populus*. (a) ARK1 chromatin immunoprecipitation sequencing (ChIP-seq) peaks associated with the promoters of class III *HD ZIP* genes. For each gene, tracks from top to bottom represent the gene size and orientation, ARK1 ChIP-seq peak called by MACS2 (red bars), mapped reads of the pooled ARK1 ChIP-seq, and mapped reads of the input control used to subtract background differences in read mapping efficiencies from ChIP-peak calling, respectively. The break lines in the mapped read tracks of *PtrHB2/popREV* (*Populus trichocarpa* HOMEBOX GENE 2/*Populus REVOLUTA*) indicate that sequence read mapping in this region was off the scale, and is not enriched in ARK1 ChIP-seq reads compared with the input control. The black arrow indicates the gene transcriptional start site (TSS) and orientation. (b) Yeast one-hybrid assay identification of five *Populus* transcription factors, including ARK1, that putatively interact with the *popREV* promoter. RAD-like (*MYB protein RADIALIS-like*) (Potri.002G260000) and NAC118 (Potri.003G022800) are positive (strong interactor) and negative (noninteractor) controls, respectively. Four additional transcription factors were able to support weak to moderate growth: Myb-like, Potri.005G063200; NAC157, Potri.004G049300; bZIP (basic leucine zipper domain protein), Potri.008G018400; and POPCORONA (PCN), Potri.001G188800. Cells were diluted to OD<sub>600</sub> of 0.100 and grown for 3 d on minimal medium deficient in His, Ura, and Trp, and in the presence of 60 mM 3-Amino-1,2,4-triazole (3-AT).



DEG = Differentially Expressed Genes

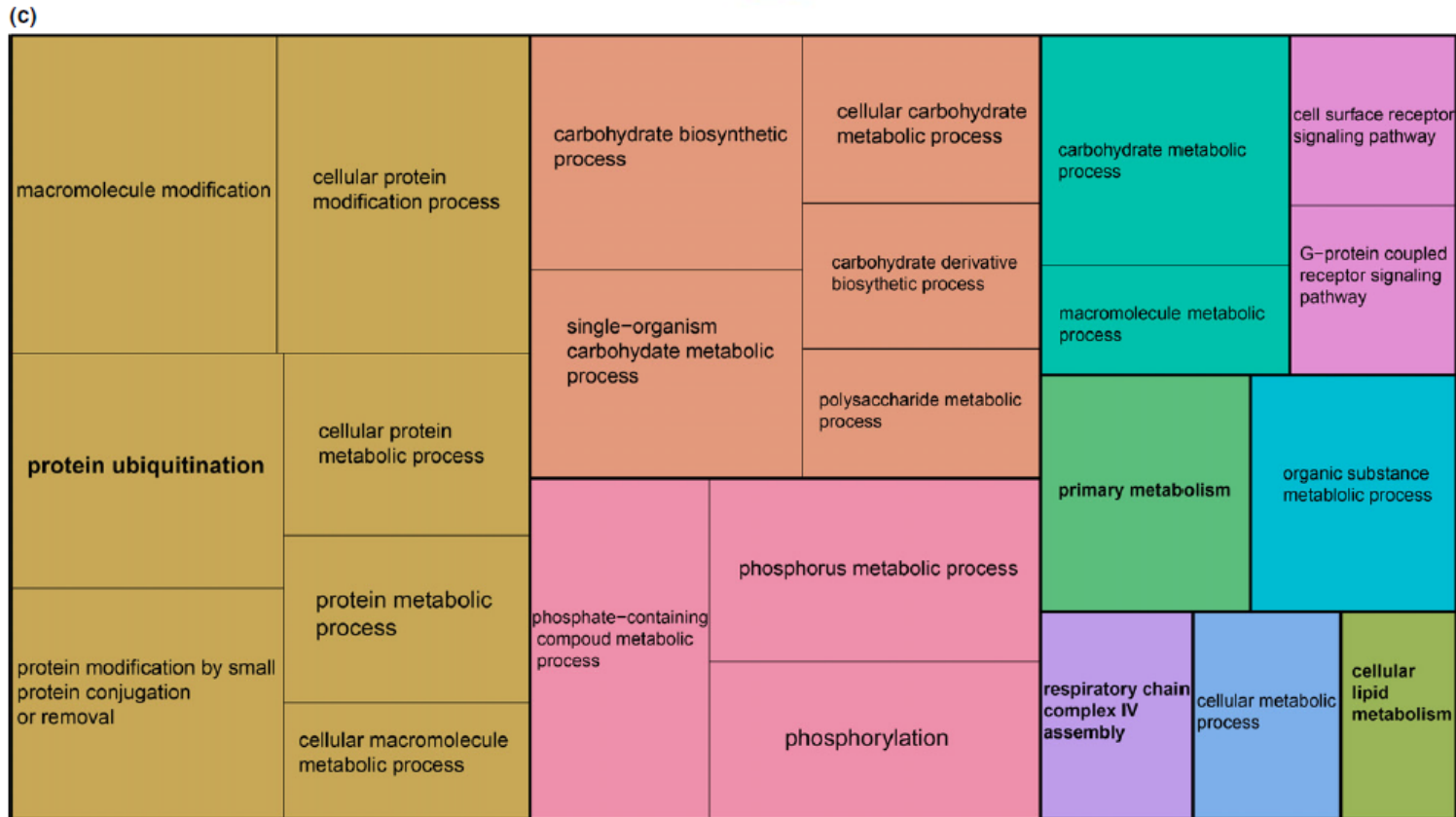
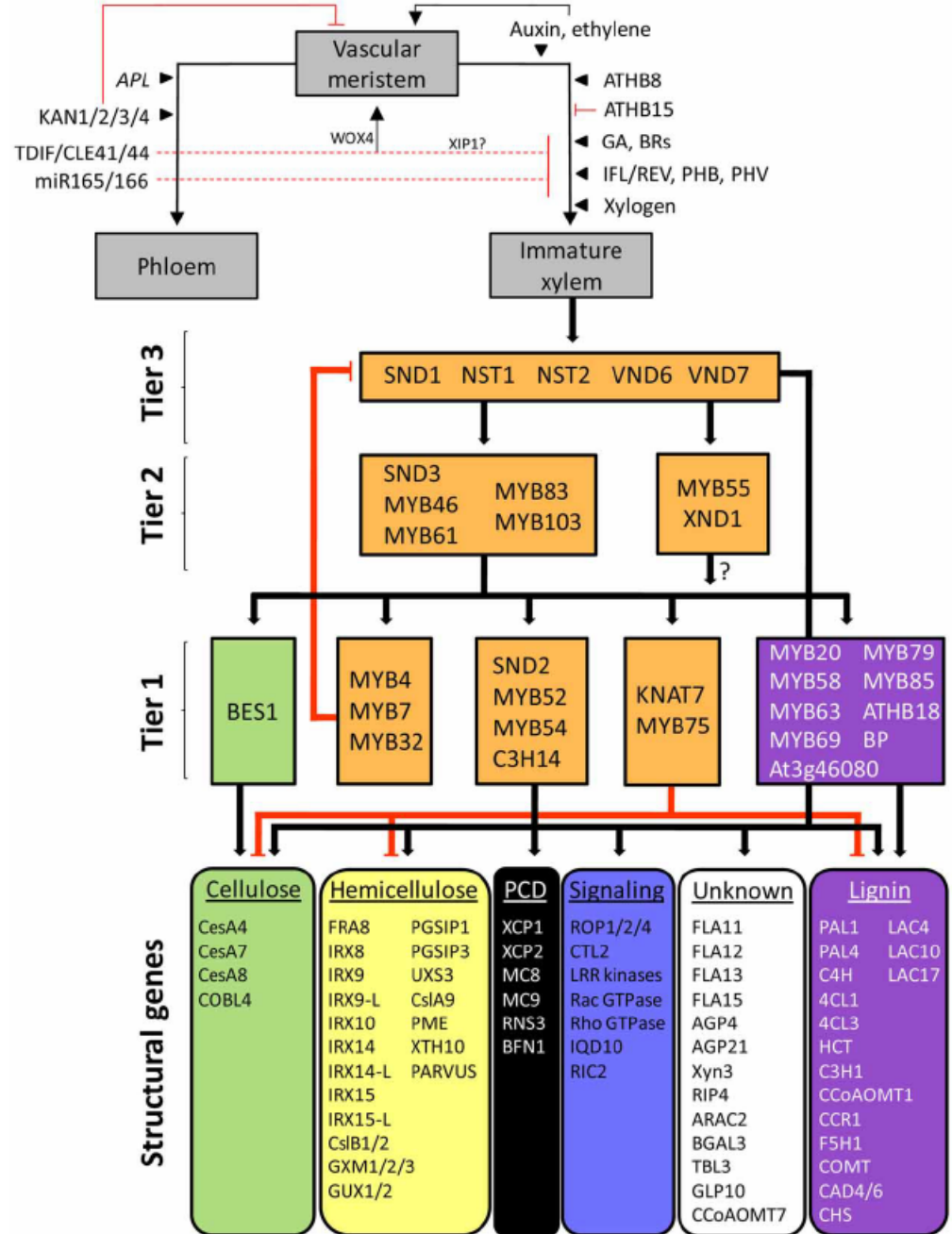

Fig. 6 Overlap between ARBORKNOX1 (ARK1) target genes and significantly differentially expressed genes in an ARK1 over-expression mutant. (a) Whole-plant phenotype of wild-type control (left) and ARK1 gain-of-function mutant (right) hybrid aspen (*Populus tremula* × *Populus alba*). Bar, 1.0 cm. (b) Venn diagram showing the overlap between ARK1 chromatin immunoprecipitation sequencing (ChIP-seq) target genes and RNA-seq significantly differentially expressed genes. (c) Visualization of enriched biological pathway gene ontology (GO) categories of the overlapping genes between ARK1 direct targets and significantly differentially expressed genes.

A light micrograph of a plant tissue section, likely a stem or root, showing various cell types. The cells are stained, highlighting their cell walls. Some cells exhibit thick, multi-layered secondary cell walls, characteristic of sclerenchyma or collenchyma. The overall structure is organized into distinct layers and regions.

**Régulation transcriptionnelle de la formation des parois secondaires**

Ce qui a été établi chez Arabidopsis



Hussey et al., 2014

# The Poplar MYB Master Switches Bind to the SMRE Site and Activate the Secondary Wall Biosynthetic Program during Wood Formation

Ruiqin Zhong, Ryan L. McCarthy, Marziyeh Haghghat, Zheng-Hua Ye 

Published: July 29, 2013 • DOI: [10.1371/journal.pone.0069219](https://doi.org/10.1371/journal.pone.0069219)

- Effects of overexpression and dominant repression of poplar orthologs of MYB46 and MYB83 on wood formation in poplar trees
- Identification of the cis-elements these MYBs bind to



**Figure 1. PtrMYB2 and PtrMYB21 are able to functionally complement the growth arrest and vessel wall-thickening defects in the Arabidopsis myb46 myb83 double mutant.**

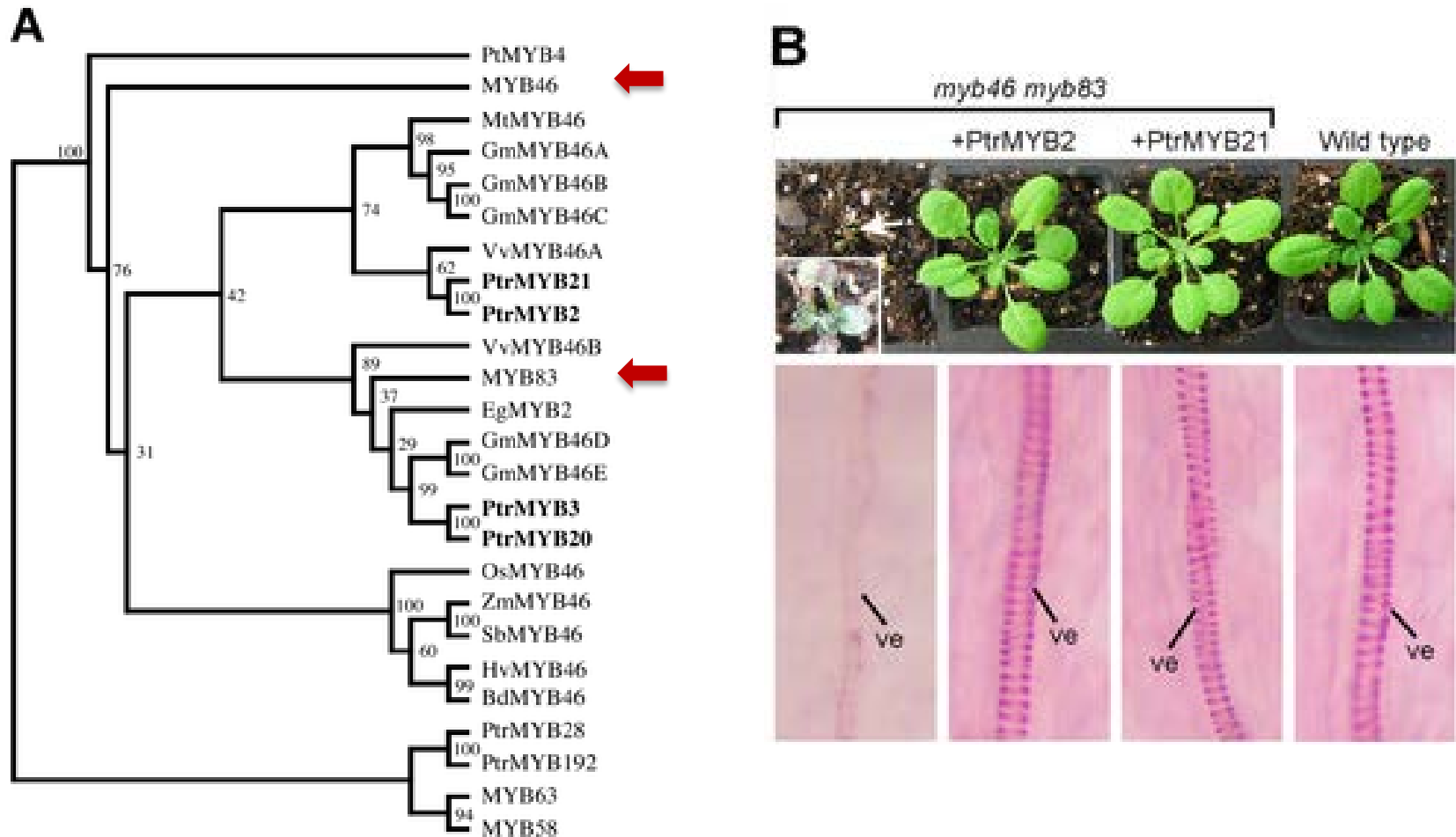

Zhong R, McCarthy RL, Haghghat M, Ye Z-H (2013) The Poplar MYB Master Switches Bind to the SMRE Site and Activate the Secondary Wall Biosynthetic Program during Wood Formation. PLoS ONE 8(7): e69219. doi:10.1371/journal.pone.0069219

<http://www.plosone.org/article/info:doi/10.1371/journal.pone.0069219>

**Figure 5. Overexpression of PtrMYB3 and PtrMYB21 causes ectopic deposition of secondary wall components in transgenic poplar stems.**

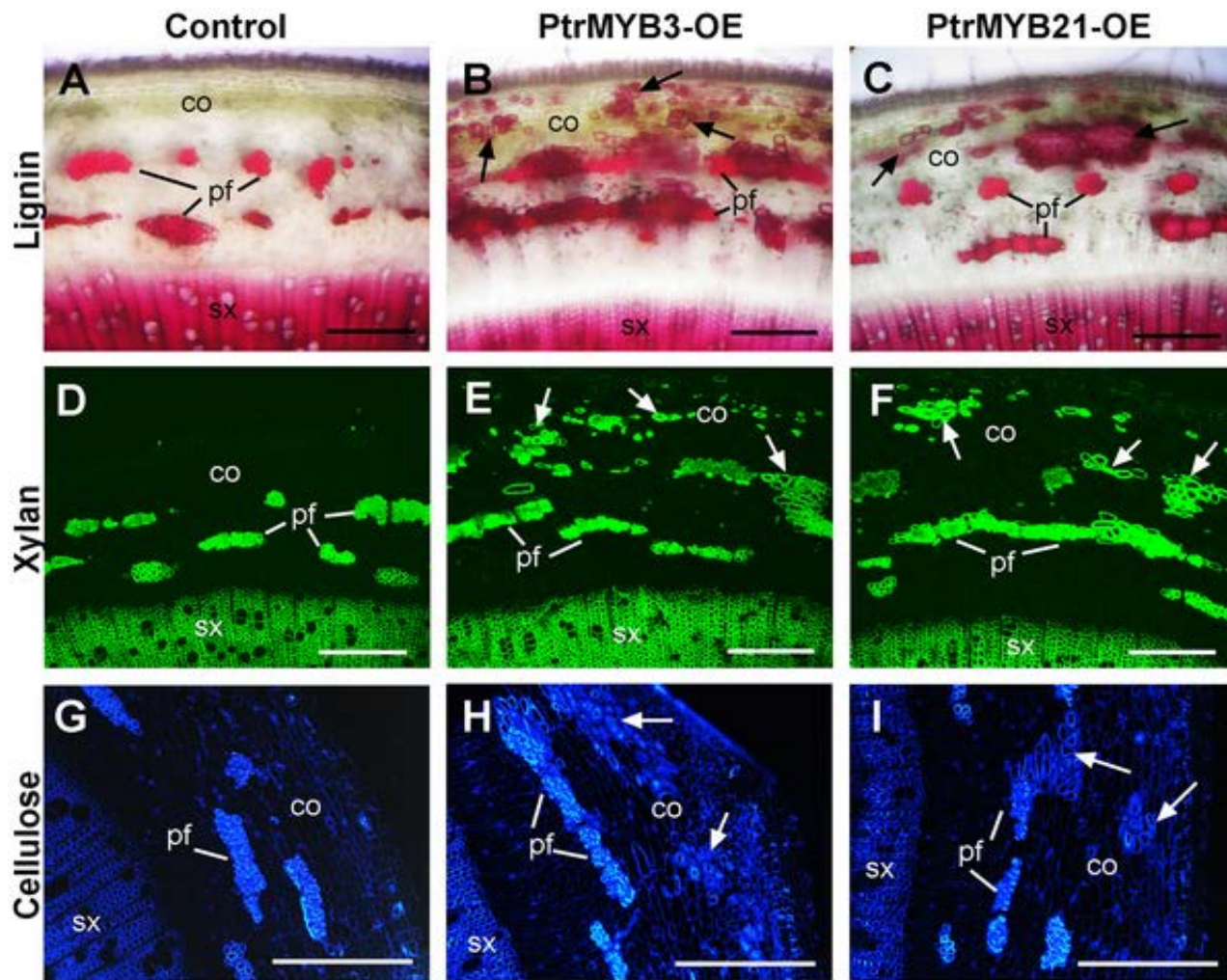

Zhong R, McCarthy RL, Haghghat M, Ye Z-H (2013) The Poplar MYB Master Switches Bind to the SMRE Site and Activate the Secondary Wall Biosynthetic Program during Wood Formation. PLoS ONE 8(7): e69219. doi:10.1371/journal.pone.0069219

<http://www.plosone.org/article/info:doi/10.1371/journal.pone.0069219>

**Figure 6. Reduction in secondary wall thickening and alteration in vessel morphology in the wood of transgenic poplar with dominant repression of PtrMYB3 (PtrMYB3-DR) and PtrMYB21 (PtrMYB21-DR).**

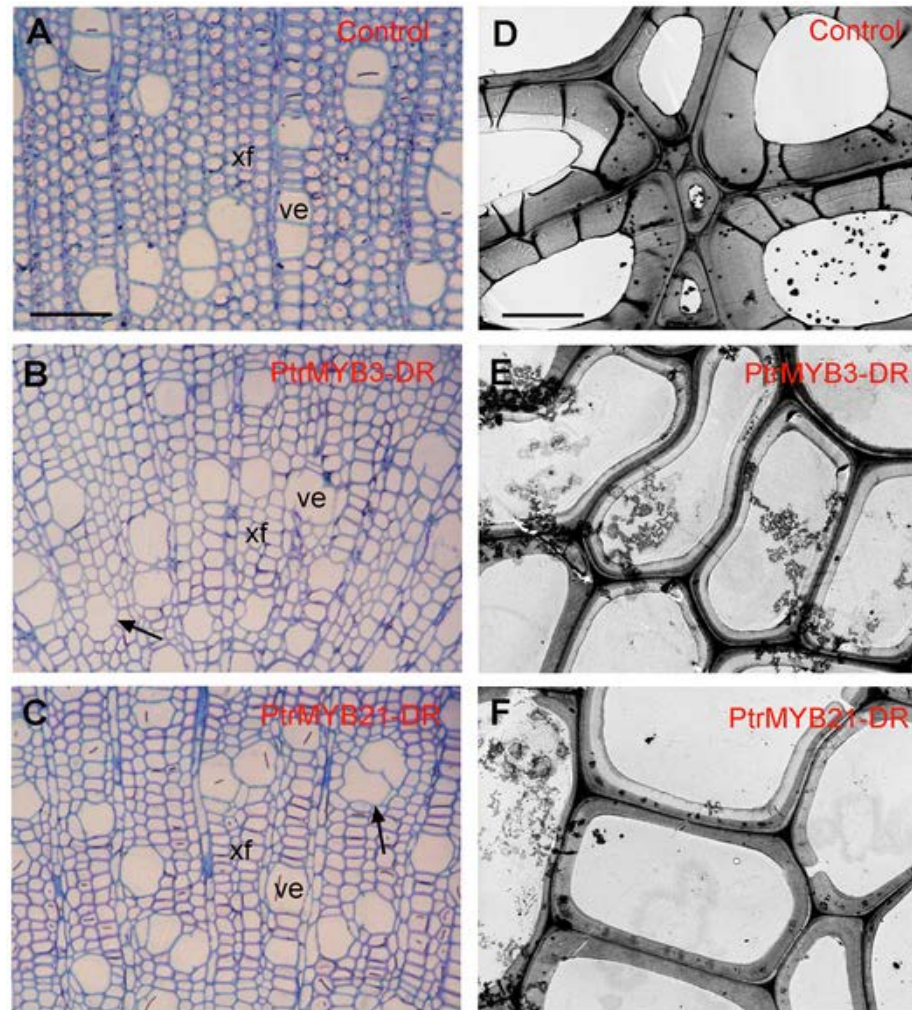

Zhong R, McCarthy RL, Haghghat M, Ye Z-H (2013) The Poplar MYB Master Switches Bind to the SMRE Site and Activate the Secondary Wall Biosynthetic Program during Wood Formation. *PLoS ONE* 8(7): e69219. doi:10.1371/journal.pone.0069219  
<http://www.plosone.org/article/info:doi/10.1371/journal.pone.0069219>

**Figure 8. Activation of SMRE-driven GUS reporter gene expression by PtrMYBs.**

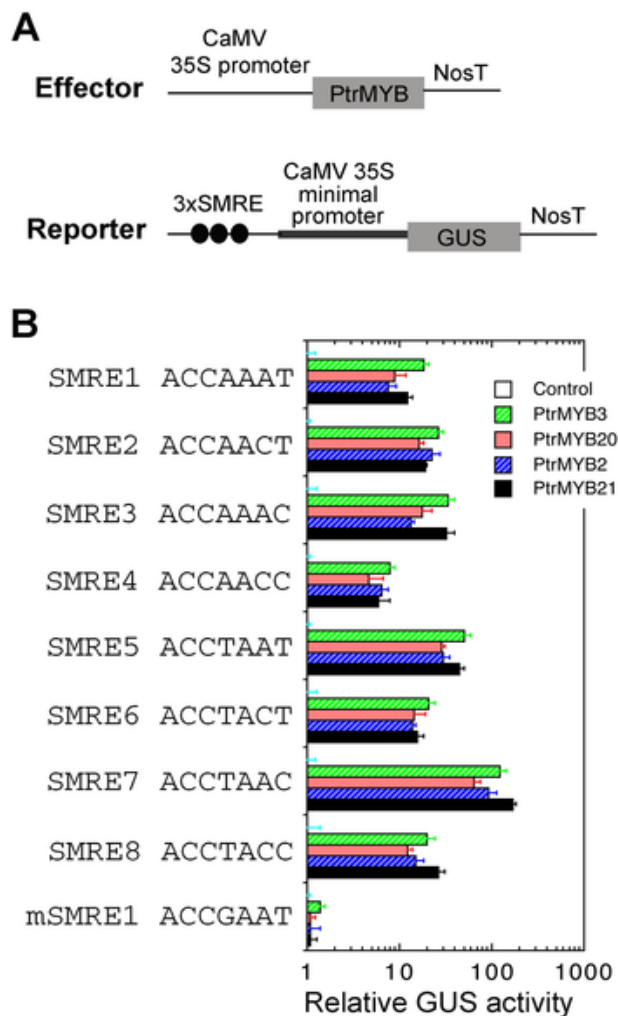

Zhong R, McCarthy RL, Haghghat M, Ye Z-H (2013) The Poplar MYB Master Switches Bind to the SMRE Site and Activate the Secondary Wall Biosynthetic Program during Wood Formation. *PLoS ONE* 8(7): e69219. doi:10.1371/journal.pone.0069219  
<http://www.plosone.org/article/info:doi/10.1371/journal.pone.0069219>

Figure 7. EMSA of binding of PtrMYB3, PtrMYB20, PtrMYB2, and PtrMYB21 to the SMRE sequences.

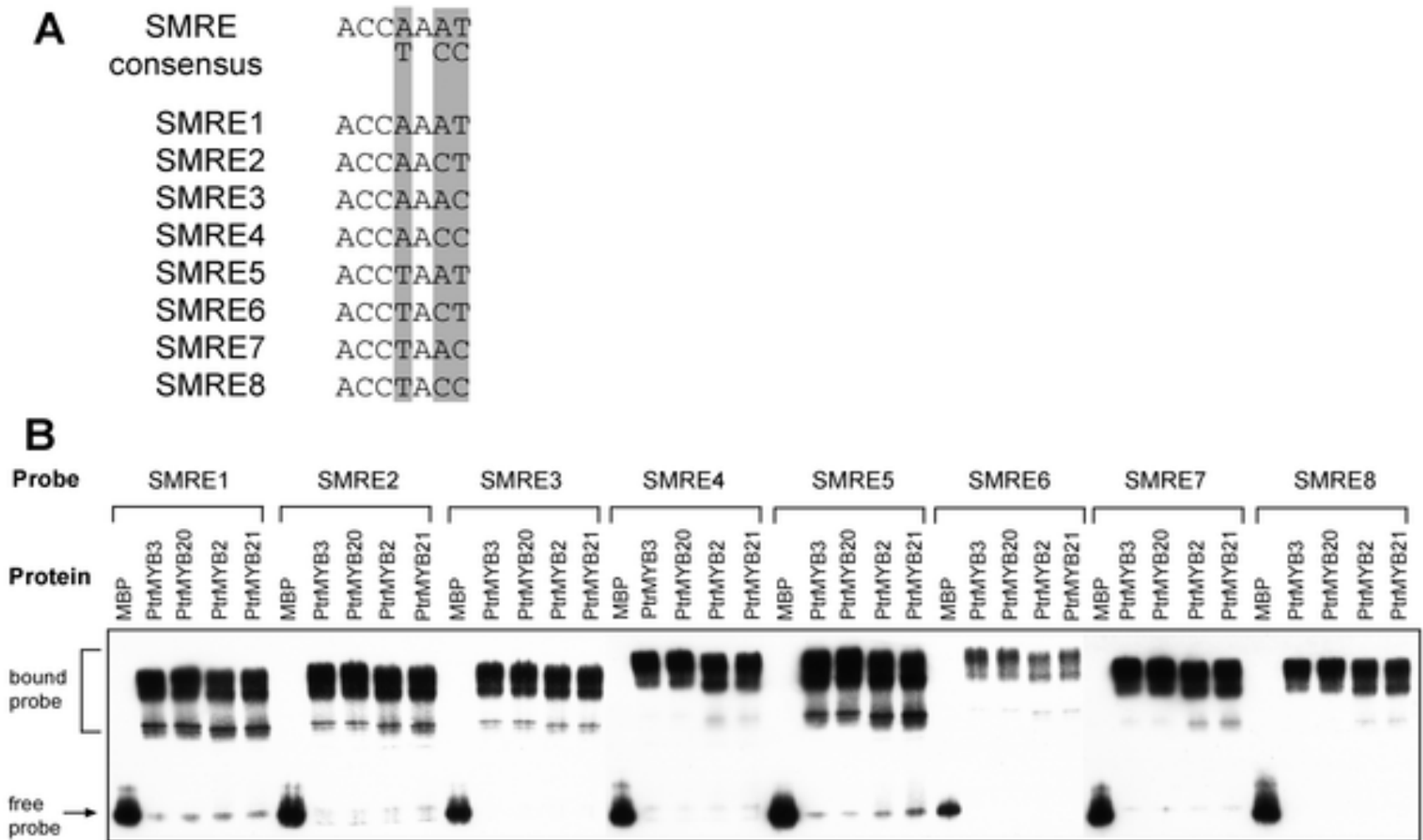

Zhong R, McCarthy RL, Haghghat M, Ye Z-H (2013) The Poplar MYB Master Switches Bind to the SMRE Site and Activate the Secondary Wall Biosynthetic Program during Wood Formation. *PLoS ONE* 8(7): e69219. doi:10.1371/journal.pone.0069219

<http://www.plosone.org/article/info:doi/10.1371/journal.pone.0069219>

**Figure 4. The promoters of poplar secondary wall biosynthetic genes are activated by poplar MYB master switches.**

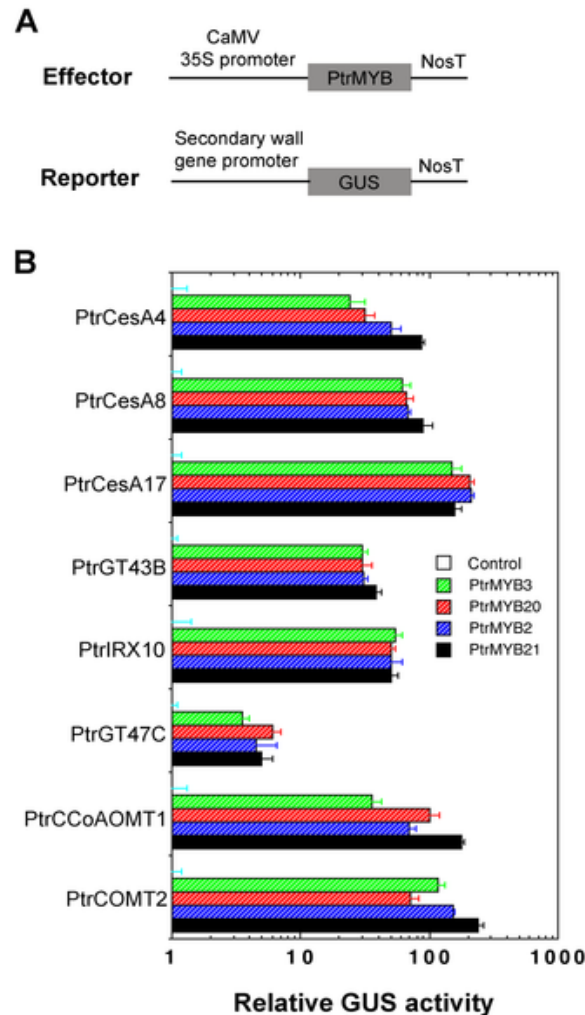

Zhong R, McCarthy RL, Haghghat M, Ye Z-H (2013) The Poplar MYB Master Switches Bind to the SMRE Site and Activate the Secondary Wall Biosynthetic Program during Wood Formation. *PLoS ONE* 8(7): e69219. doi:10.1371/journal.pone.0069219  
<http://www.plosone.org/article/info:doi/10.1371/journal.pone.0069219>

A grayscale micrograph showing a network of cellulose microfibrils within plant cells. The microfibrils are arranged in a complex, interconnected pattern, forming a mesh-like structure. The cells themselves are visible as large, irregular shapes with thick, dark walls. The microfibrils are lighter in color and show varying orientations and thicknesses, indicating their role in cell structure and function.

**Contrôle de l'angle des  
microfibrilles de cellulose**

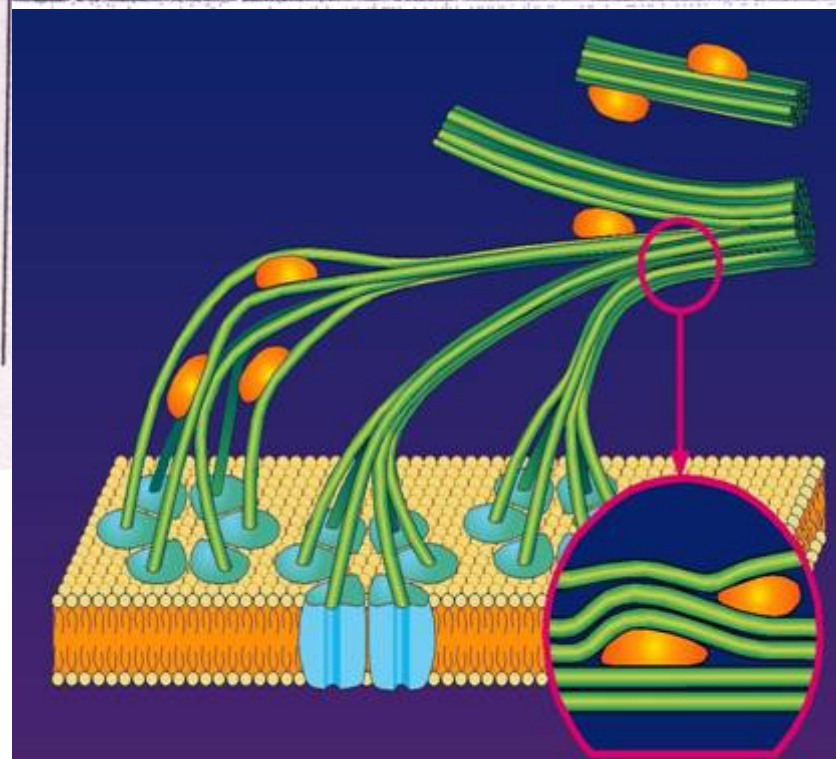
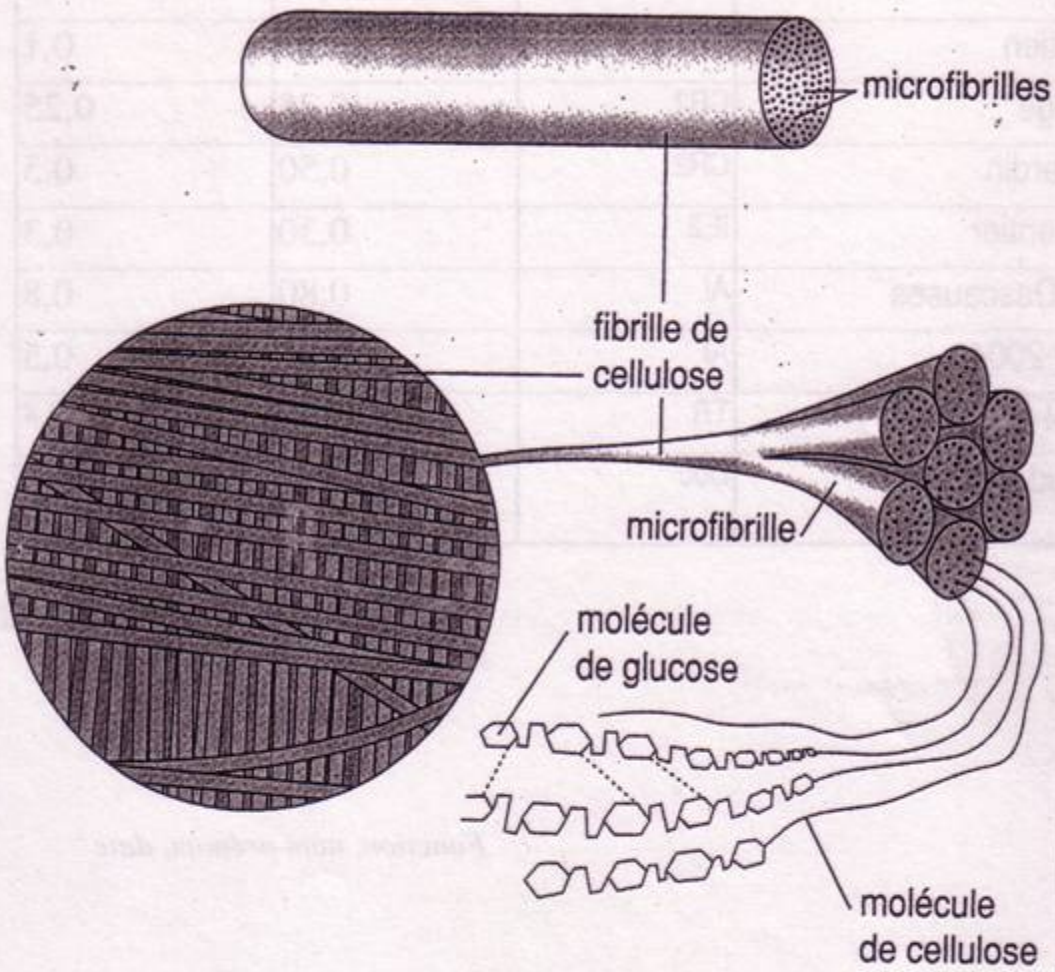



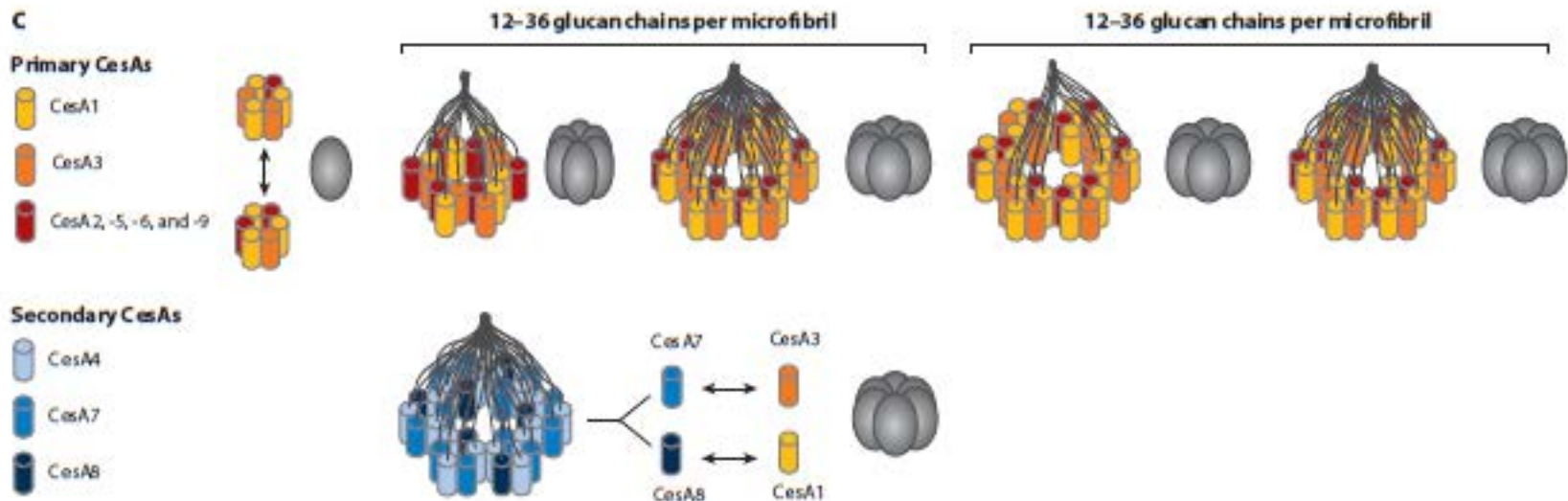
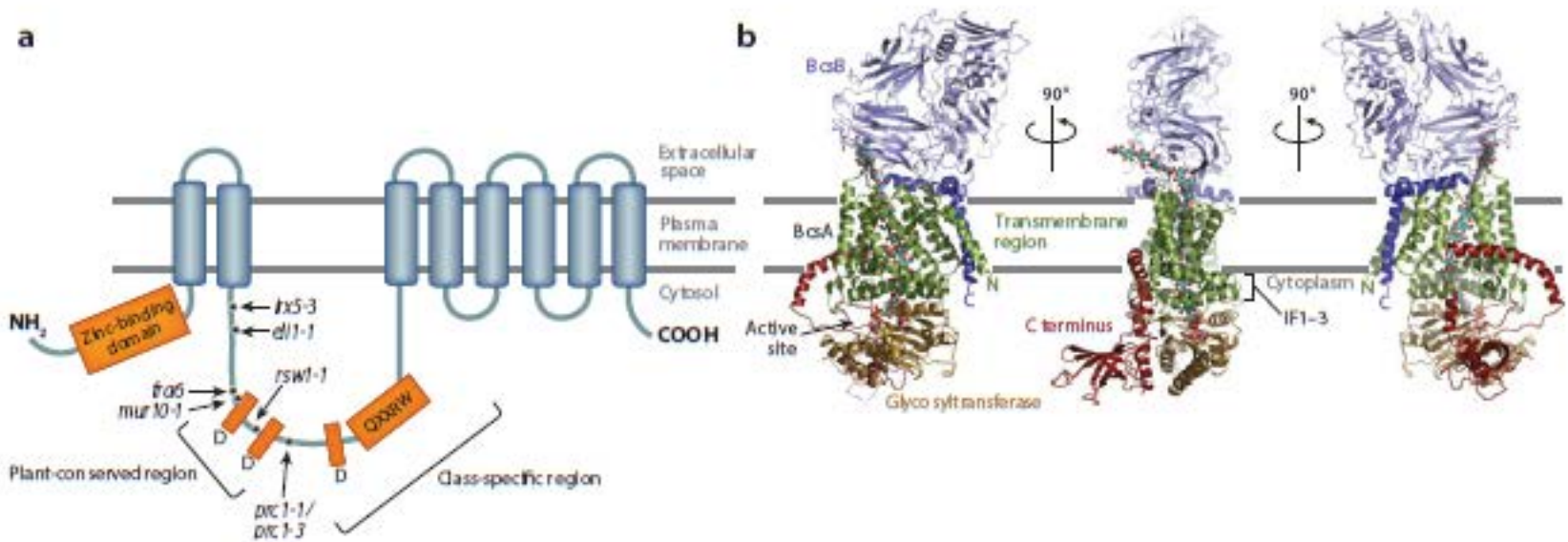

(MacFarlane et al., 2014)

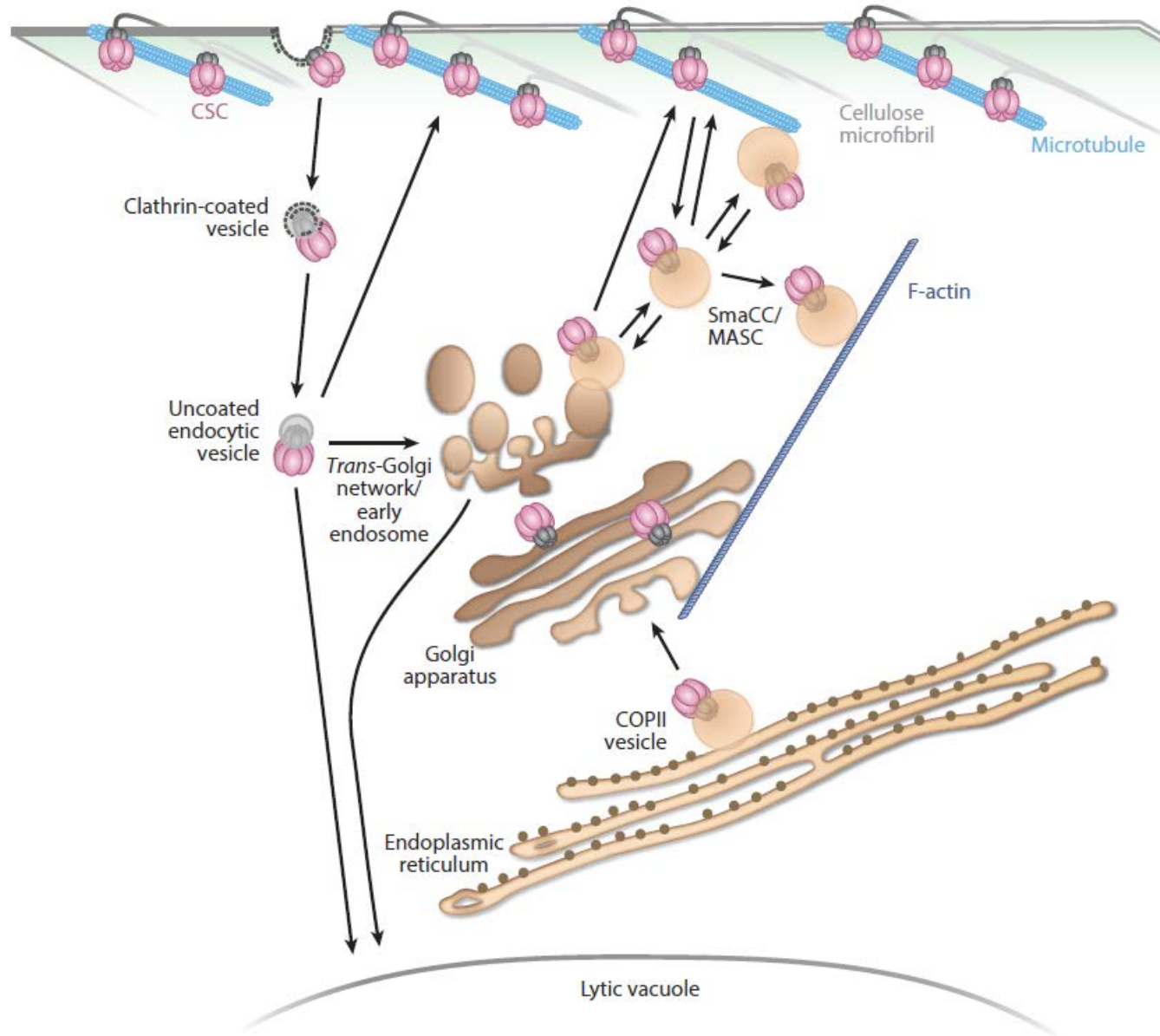

(MacFarlane et al., 2014)

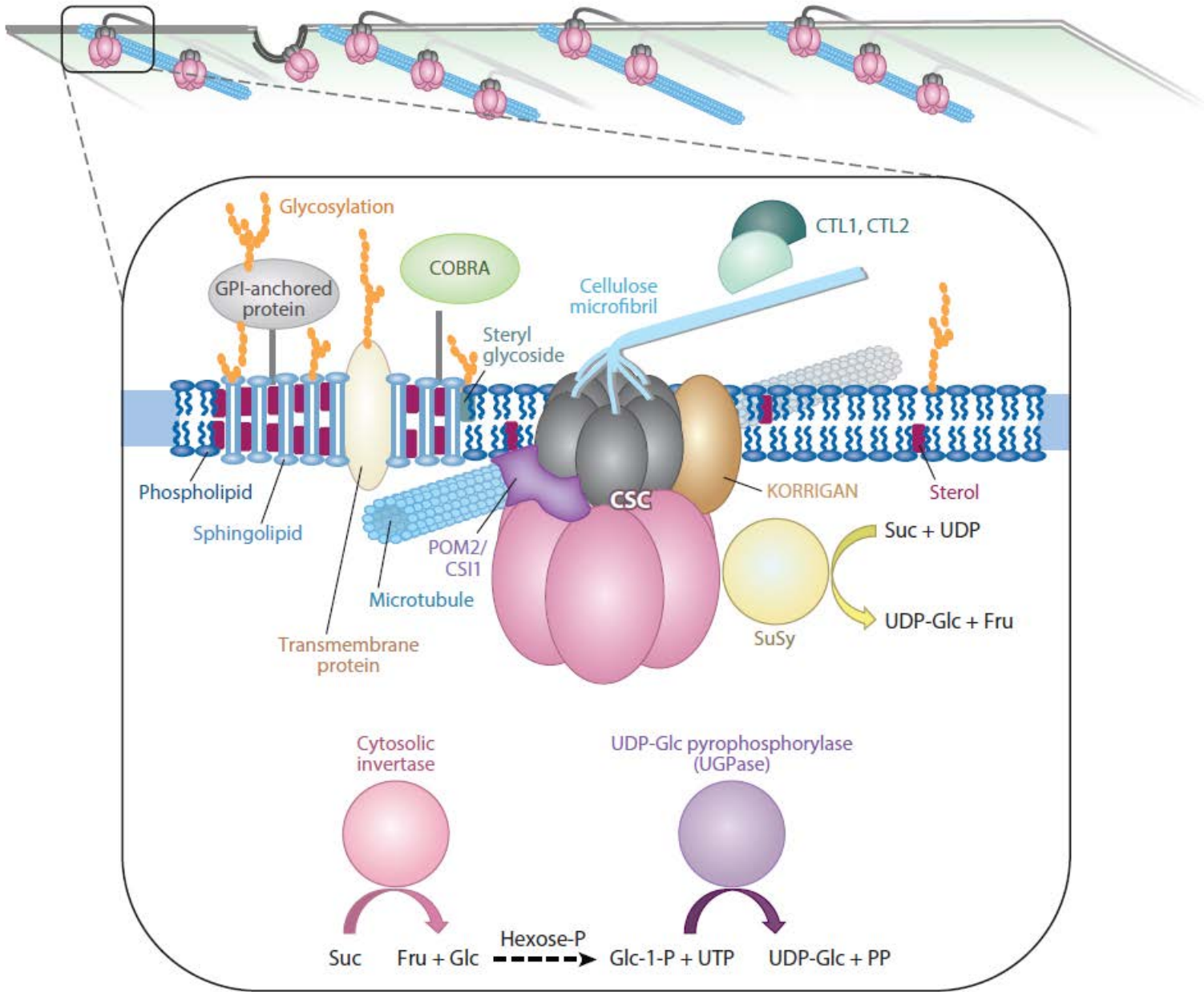

(MacFarlane et al., 2014)

A microscopic image of plant tissue, likely a cross-section of a stem or root, showing various vascular bundles. The bundles are arranged in a somewhat regular pattern, with some showing distinct xylem and phloem regions. The word "Conclusions" is overlaid in the center in a bold, blue font.

# Conclusions

- Intérêt des études sur modèles type Arabidospis
- Besoin de travaux sur les arbres, même si plus long

Depuis qqes années, développement d'approche de Biologie des systèmes

# Vers une approche réseau de gènes

Ex : paroi secondaire Arabidopsis

Promoteurs 50 gènes connus /  
criblage 460 facteurs de  
transcription exprimés dans le  
xylème (racine)

→ Réseau 240 gènes /  
600 nouvelles interactions

1 gène / 5 facteurs de  
transcription

Beaucoup de boucles « feed-  
forward »

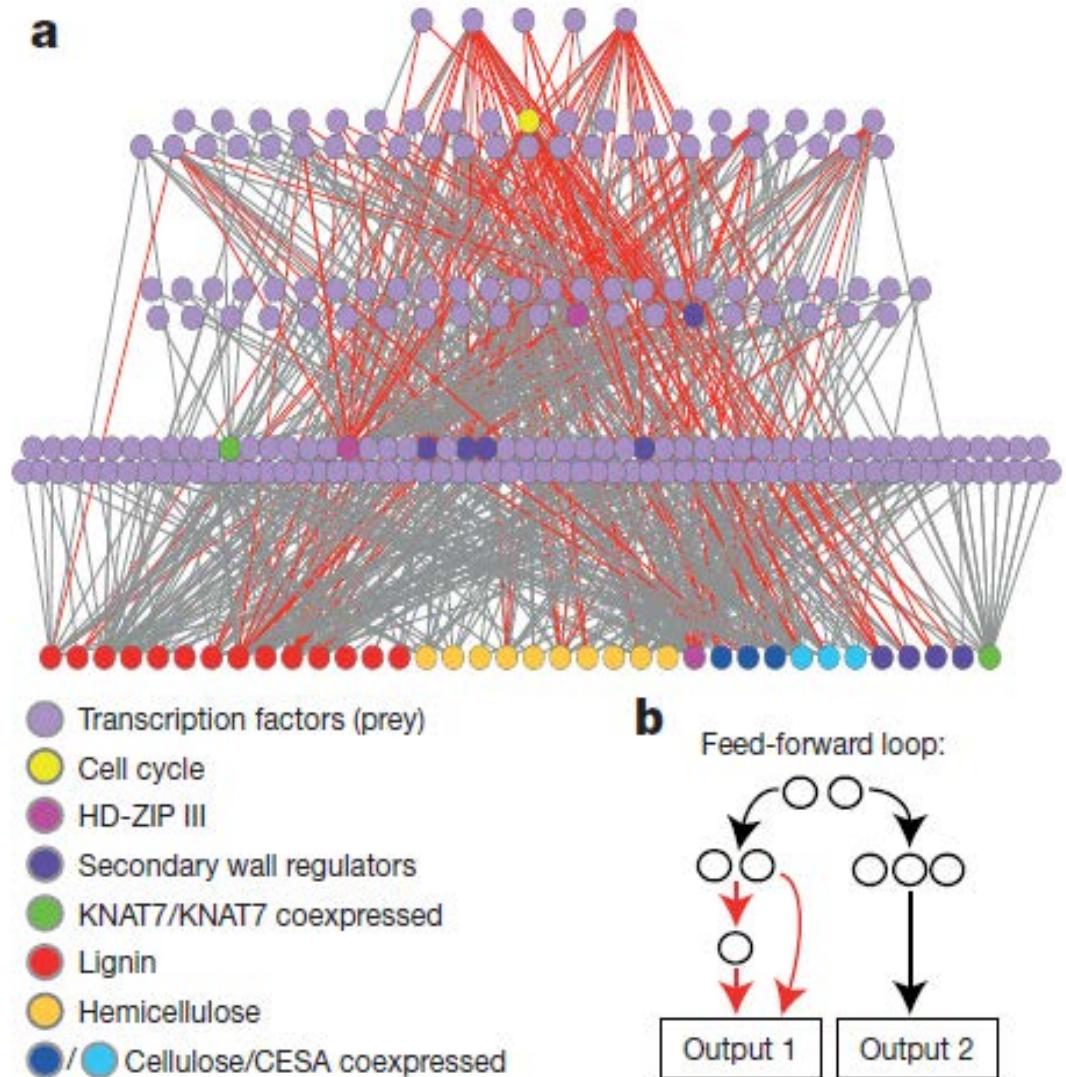

# Approche de biologie des systèmes

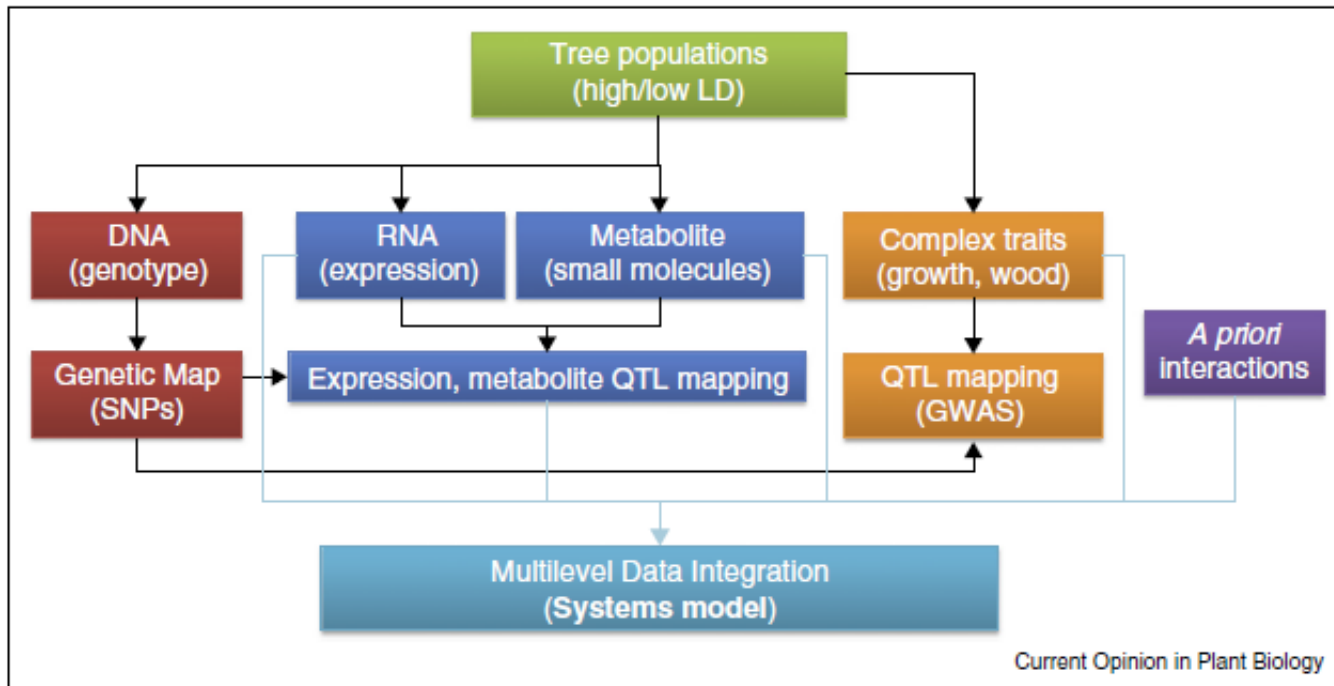

Integration of component data in a systems model. Trees in structured or unstructured populations are genotyped for construction of a framework expression map. Gene expression and metabolite levels are measured, and genetic signal for their variation is calculated via eQTL mapping/ GWAS. These data can be integrated with a priori interactions (e.g. membership in a pathway or process, protein/protein or known directional regulatory relationships) and complex growth, wood or processing traits to construct a working model. Methodology for this type of multilevel data integration is still evolving.

(Mizrachi et Myburg, 2016)

# Etablissement de réseaux biologiques

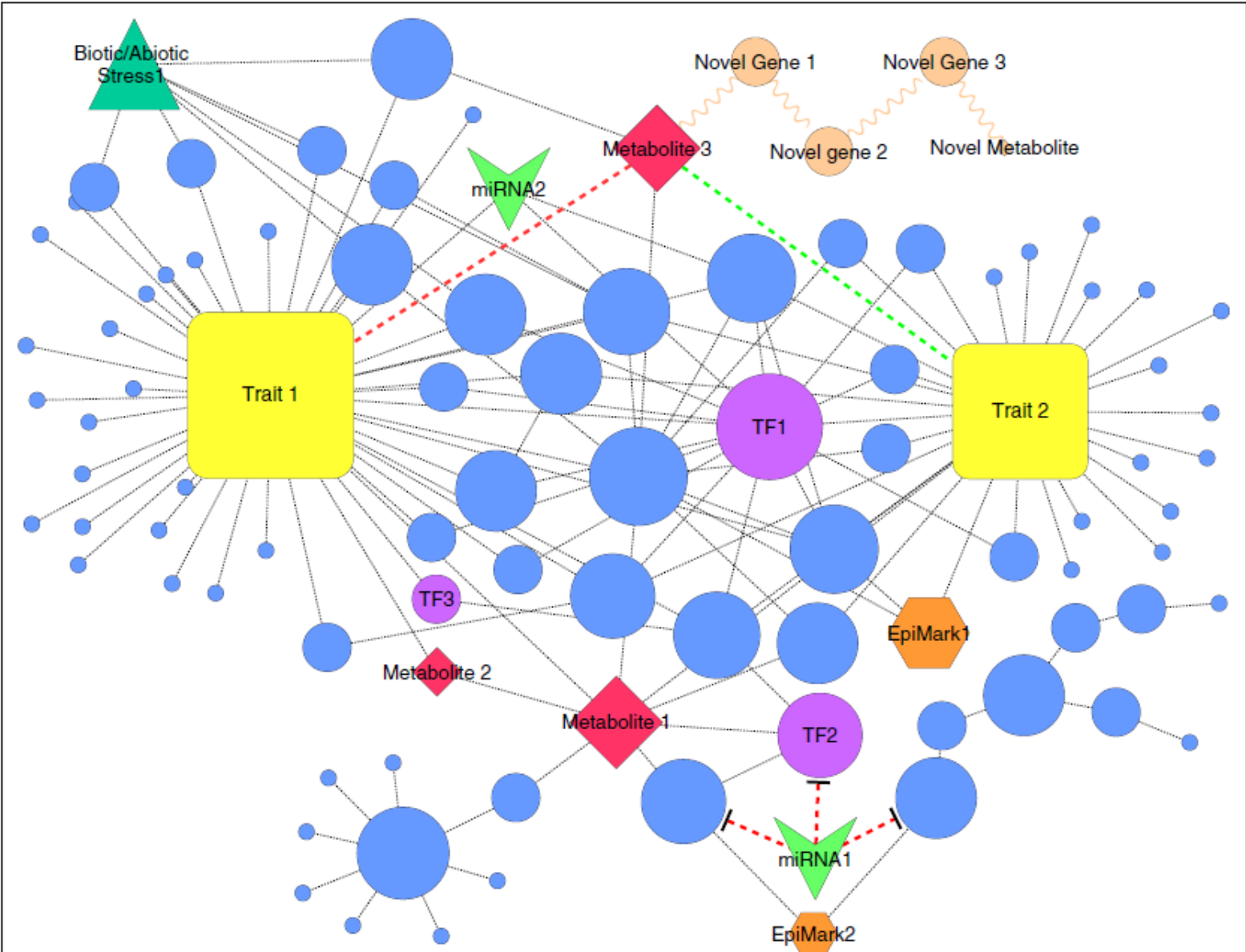

(Mizrachi et Myburg, 2016)



# Futur : modification à façon du génome / genome editing

Review

Trends in Biotechnology, July 2013, Vol. 31, No. 7



## ZFN, TALEN, and CRISPR/Cas-based methods for genome engineering

Thomas Gaj<sup>1,2,3</sup>, Charles A. Gersbach<sup>4,5</sup>, and Carlos F. Barbas III<sup>1,2,3</sup>

Zinc-finger nucleases (ZFNs) and transcription activator-like effector nucleases (TALENs) comprise a powerful class of tools that are redefining the boundaries of biological research. These chimeric nucleases are composed of programmable, sequence-specific DNA-binding modules linked to a nonspecific DNA cleavage domain. ZFNs and TALENs enable a broad range of genetic modifications by inducing DNA double-strand breaks that stimulate error-prone nonhomologous end joining or homology-directed repair at specific genomic locations. Here, we review achievements made possible by site-specific nuclease technologies and discuss applications of these reagents for genetic analysis and manipulation.

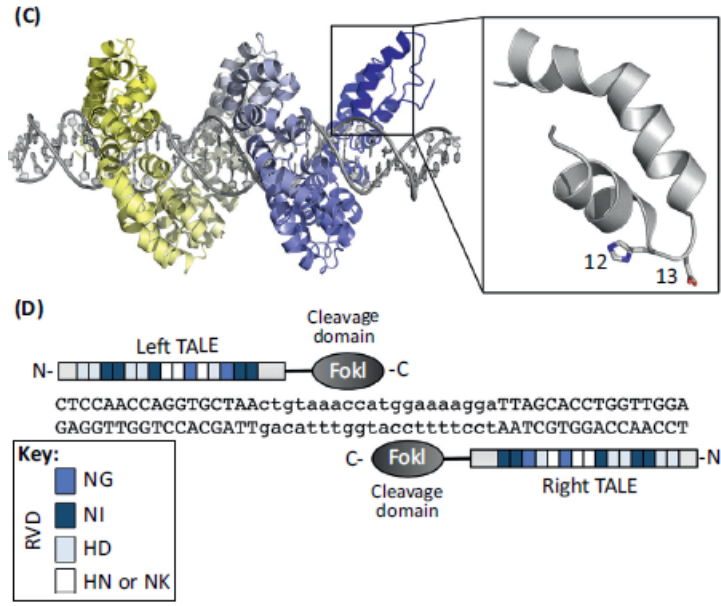

# Utilisations possibles de nucléases site-spécifiques pour manipuler le génome

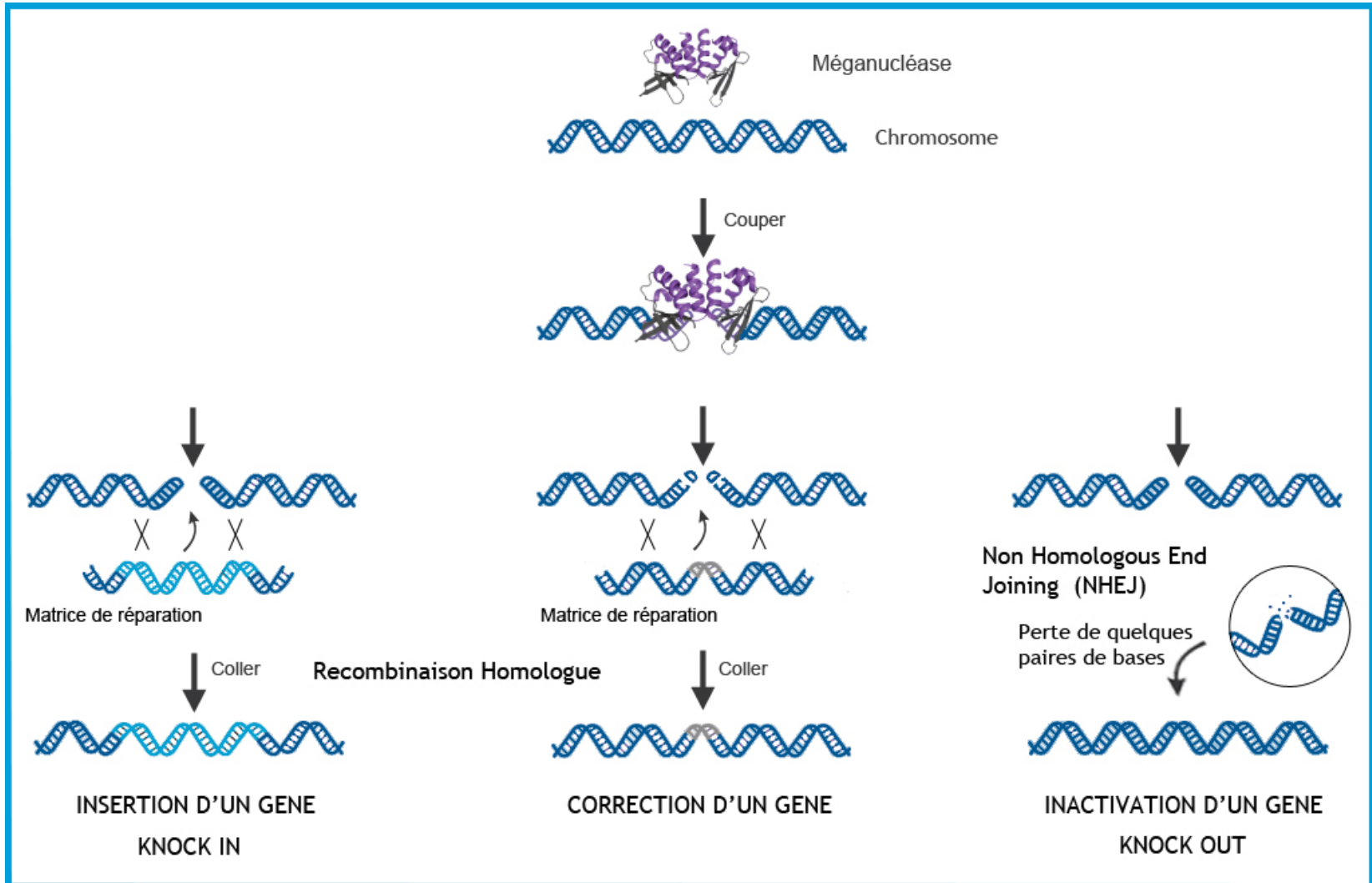

# Système CRISPR-Cas9 = endonucléases ARN-guidées

Phase 1: immunization

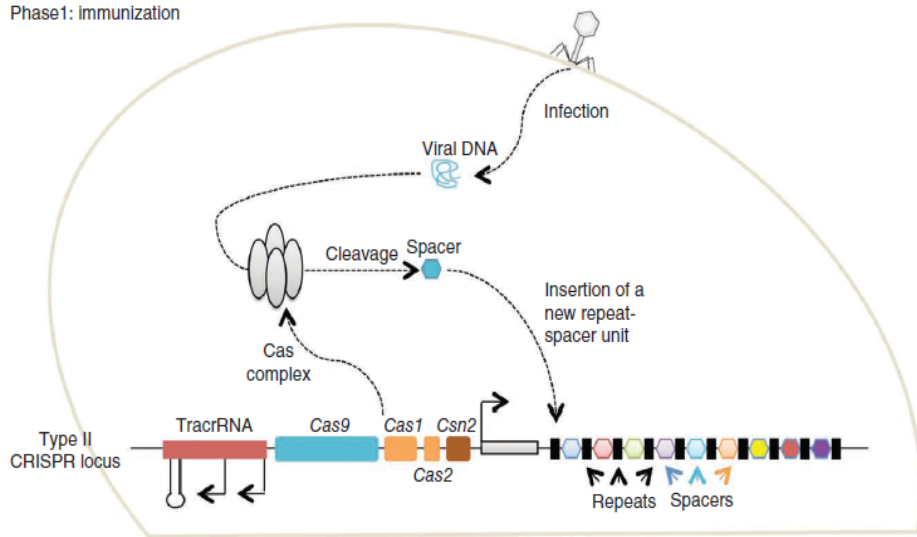

Phase 2: immunity

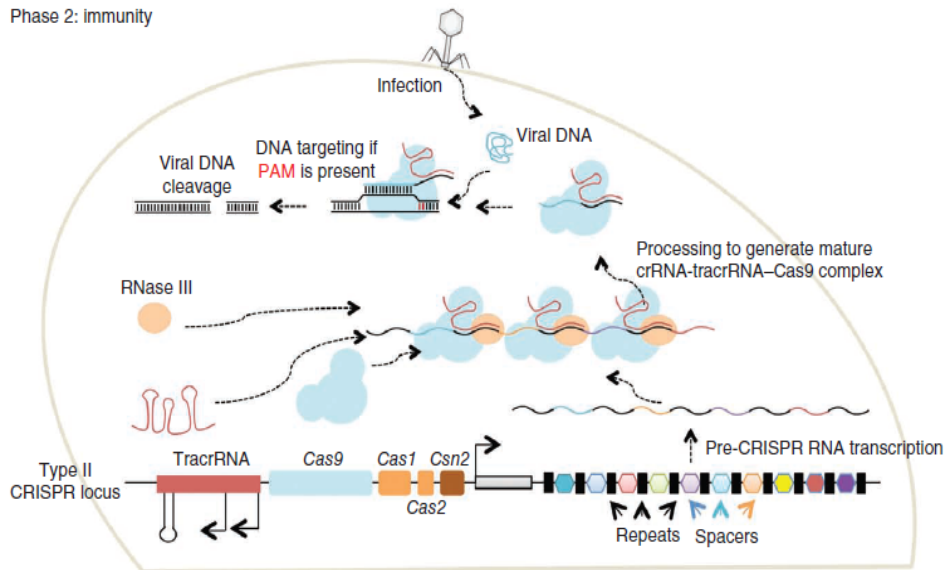

CRISPR = Clustered Regularly Interspaced Short Palindromic Repeats

Provient du système immunitaire bactérien pour se défendre de l'ADN exogène

Système très versatile : même nuclease, seul l'ARN guide change pour chaque nouvelle cible

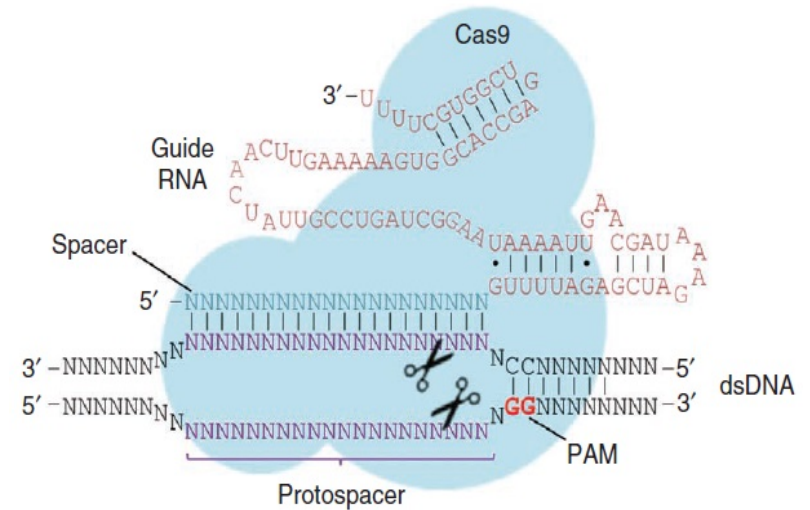

Mali et al, 2013

# Démonstration de l'efficacité du système CRISPR-CAS9 sur peuplier

Démonstration sur la famille oligogénique des **4CL** (4-coumarate:CoA ligase)

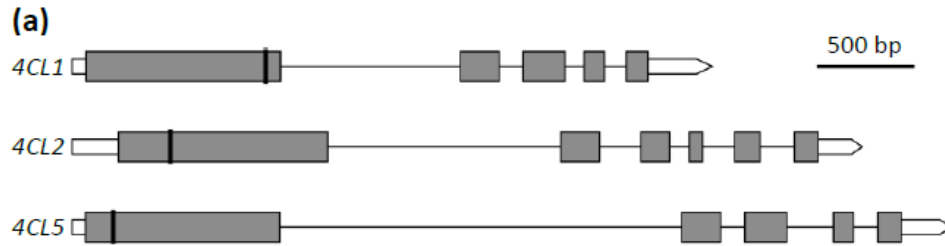

(b) **4CL1-gRNA**

Potri.001G036900	GAGGATGATAAAATCTGGAGGGG	←
717.4CL1	GAGGATGATAAAATCTGGAGGGG	
Potri.003G188500	GAGGATGTTGAAGTCTGGAGGGT	←
717.4CL5	GAGGATGTTGAAGTCTGGAGGGT	
Potri.006G169700	TCGGACCGTAATGTCTGGCGCCG	
717.4CL3	TCGGACCGTAATGTCTGGCGCCG	
Potri.006G169600	TCGGACCGTAATGTCTGGCGCCG	
717.4CL6	TCGGACCGTAATGTCTGGCGCCG	
Potri.018G094200	CCGGACRGTMCTGTCTGGCGCAG	
717.4CL4	CCGGACRGTMCTGTCTGGCGCAG	
Potri.019G049500	CAGGGTAGTCCTSTCAGGGGCTG	
717.4CL2	CAGGGTAGTCCTGT CAGGGGCTG	

**4CL2-gRNA**

Potri.019G049500	GCTGCTGGGTTATCCAATTTGGG
717.4CL2	GCTGCTGGGTTATCCAATTTGGG
Potri.006G169700	GCTTCCGGCCTCAGCAAGTTAGG
717.4CL3	GCTTCCGGCCTCAGCAAGTTAGG
Potri.006G169600	GCTTCCGGCCTCAGCAAGTTAGG
717.4CL6	GCTTCCGGCCTCAGCAAGTTAGG
Potri.018G094200	GCCTCTGGCCTCTACARGTTAGG
717.4CL4	GCCTCTGGCCTCTACARGTTAGG
Potri.001G036900	GCTTCTGGTCTKAACAAGATTGG
717.4CL1	GCTTCTGGTCTGAACAAGATTGG
Potri.003G188500	GCTTCYGGTCTTAACAAGCTTGG
717.4CL5	GCTTCYGGTCTTAACAAGCTTGG

**4CL5-gRNA**

Potri.003G188500	GTCTGATAAAATGGCGCAAATGGG
717.4CL5_1	GTCTGATAAAATGGCGAAAATGGG
717.4CL5_2	GTCTGATAAAATGGCGCAAATGGA
Potri.001G036900	GCCTGATAAAATGGYGCRAAYGGA
717.4CL1	GCCTGATAAAATGGYGCRAAYGGA
Potri.006G169700	GTTTGATCAATGGCCCTACCGGT
717.4CL3	GTTTGATCAATGGCCCTACCGGT
Potri.006G169600	GTTTGATCAATGGCCCTACCGGT
717.4CL6	GTTTGATCAATGGCCCTACCGGT
Potri.018G094200	GCTTGATCAATGGCCCTACCGGT
717.4CL4	GCTTGATCAATGGCCCTACCGGT
Potri.019G049500	GCTTGATTT CAGGTTCCACGGGA
717.4CL2	GCTTGATTT CAGGTTCCACGGGA

GCTGCTGGGTTATCCAATTTGGG  
 GCTGCTGGGTTATCCAATTTGGG  
 GCTTCCGGCCTCAGCAAGTTAGG  
 GCTTCCGGCCTCAGCAAGTTAGG  
 GCTTCCGGCCTCAGCAAGTTAGG  
 GCTTCCGGCCTCAGCAAGTTAGG  
 GCCTCTGGCCTCTACARGTTAGG  
 GCCTCTGGCCTCTACARGTTAGG  
 GCTTCTGGTCTKAACAAGATTGG  
 GCTTCTGGTCTGAACAAGATTGG  
 GCTTCYGGTCTTAACAAGCTTGG  
 GCTTCYGGTCTTAACAAGCTTGG

GTCTGATAAAATGGCGCAAATGGG  
 GTCTGATAAAATGGCGAAAATGGG  
 GTCTGATAAAATGGCGCAAATGGA  
 GCCTGATAAAATGGYGCRAAYGGA  
 GCCTGATAAAATGGYGCRAAYGGA  
 GTTTGATCAATGGCCCTACCGGT  
 GTTTGATCAATGGCCCTACCGGT  
 GTTTGATCAATGGCCCTACCGGT  
 GTTTGATCAATGGCCCTACCGGT  
 GCTTGATCAATGGCCCTACCGGT  
 GCTTGATCAATGGCCCTACCGGT  
 GCTTGATTT CAGGTTCCACGGGA  
 GCTTGATTT CAGGTTCCACGGGA

Selection of 1 gRNA / gene target based RNA-Seq data from **717-1B4** and the reference genome (*P. trichocarpa*)

# Démonstration de l'efficacité du système CRISPR-CAS9 sur peuplier

Ex : 4CL1: 100% efficacité, chaque transformant porte une modification bi-allèlique

(a)

Line	Target sequence (GN19NGG)	% reads indel		
717	AGTCACCTGATCTTGACAAGCATGACTTGTCTTCTTTGAGGATGATAAAATCTG . GAGGGGCTC GGTCACCTGATCTTGACAAGCATGACTTGTCTTCTTTGAGGATGATAAAATCTG . GAGGGGCTC	50	-	
C-18	AGTCACCTGATCTTGACAAGCATGACTTGTCTTCTTTGAGGATGATAAAATCTG . GAGGGGCTC GGTCACCTGATCTTGACAAGCATGACTTGTCTTCTTTGAGGATGATAAAATCTG . GAGGGGCTC	49	-	
C-39	AGTCACCTGATCTTGACAAGCATGACTTGTCTTCTTTGAGGATGATAAAATCTG . GAGGGGCTC GGTCACCTGATCTTGACAAGCATGACTTGTCTTCTTTGAGGATGATAAAATCTG . GAGGGGCTC	50	-	
1-14	AGTCACCTGATCTTGACAAGCATGACTTGTCTTCTTTGAGGATGATAAAATCT- . GAGGGGCTC GGTCACCTGATCTTGACAAGCATGACTTGTCTTCTTTGAGGATGATAAAATCT- . GAGGGGCTC	34	-1	
4CL1	1-39	AGTCACCTGATCTTGACAAGCATGACTTGTCTTCTTTGAGGATGATAAAATCT- . GAGGGGCTC GGTCACCTGATCTTGACAAGCATGACTTGTCTTCTTTGAGGATGATAAAATCT- . GAGGGGCTC	48	-1
	1-42	AGTCACCTGAGCTTGAGTAGCATGACTTGTCTTCTTTGAGGATGATTAATCTGTGAGGGGCTC GGTCACCTGATCTTGACAAGCATGACTTGTCTTCTTTGAGGATGATAAAATCT- . GAGGGGCTC	56	+1
1-53	AGTCACCTGATCTTGACAAGCATGACTTGTCTTCTTTGAGGATGATAA----- . AGGGGCTC GGTCACCTGATCTTGACAAGCATGACTTGTCTTCTTTGAGGATGATAAAATCT- . GAGGGGCTC	52	-7	
1-61	AGTCACCTGATCTTGACAAGCATGACTTGTCTTCTTTGAGGATGATAAAATCT- . GAGGGGCTC GGTCACCTGATCTTGACAAGCATGACTTGTCTTCTTTGAGGATGATAAAATCT- . GAGGGGCTC	49	-1	
1-68	AGTCACCTGATCTTGACAAGCATGACTTGTCTTCTTTGAGGATGATAAAA----- . GAGGGGCTC GGTCACCTGATCTTGACAAGCATGACTTGTCTTCTTTGAGGATGATAAAATCT- . GAGGGGCTC	35	-4	

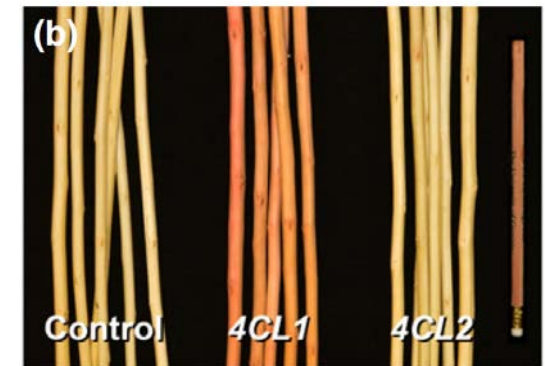

Phenotype observed in agreement with gene KO of 4CL1 and 4CL2

Zhou et al., New Phytol, 2015

# Références

- Déjardin et al. (2010). Wood formation in Angiosperms. *CRAS Biologies* 333, 325-334.
- Demura, T., and Fukuda, H. (2007). Transcriptional regulation in wood formation. *Trends in Plant Science* 12, 64-70.
- Hertzberg et al. (2001). A transcriptional roadmap to wood formation. *Proc. Natl. Acad. Sci. USA* 98, 14732-14737
- Hussey et al (2013) Navigating the transcriptional roadmap regulating plant secondary cell wall deposition. *Frontiers in Plant Science*. 4:325.
- Liu et al (2015). The Populus ARBORKNOX1 homeodomain transcription factor regulates woody growth through binding to evolutionarily conserved target genes of diverse function. *New Phytologist* 205: 682–694
- McFarlane et al. (2014). The cell biology of cellulose synthesis, *Annu Rev Plant Biol.*, 65:69-94.
- Mizrachi et Myburg (2016). Systems genetics of wood formation. *Curr Opin Plant Biol.*, 30:94-100
- Plomion et al. (2001). Wood formation in trees, *Plant Physiol*, 127(4):1513-23.
- Rathgeber et al. (2016). Biological Basis of Tree-Ring Formation: A Crash Course. *Front Plant Sci.*;7:734
- Taylor-Teeple et al. (2015). An Arabidopsis gene regulatory network for secondary cell wall synthesis. *Nature*, 517(7536):571-5.
- Zhong et Ye (2014) Complexity of the transcriptional network controlling secondary wall biosynthesis. *Plant Science* 229 (2014) 193–207
- Zhong R, McCarthy RL, Haghghat M, Ye Z-H (2013) The Poplar MYB Master Switches Bind to the SMRE Site and Activate the Secondary Wall Biosynthetic Program during Wood Formation. *PLoS ONE* 8(7): e69219